

CAV

**FOR RELIABILITY
AND SAFETY AT SEA**

CAV Diesel Fuel Injection Equipment for the Boat Owner

Diesel reliability! A phrase that boat owners and skippers may sometimes doubt when they are faced with an engine that stubbornly refuses to start, that runs erratically or emits vast clouds of black exhaust smoke. Nevertheless it is a true statement. Diesel engines, or, as they should properly be called, compression ignition engines, are incredibly reliable when properly maintained and because of this fact are increasingly used as marine propulsion units.

Despite this increasingly widespread use, these engines and, more particularly, their associated fuel injection equipment, remain somewhat of a mystery to the uninitiated. In consequence, the normal preventative maintenance is often skimmed and faults develop. In extreme cases, a simple fault that develops at sea and could easily be rectified by the average owner or skipper if they had the technical knowledge, becomes the cause of an emergency involving expensive rescue operations.

It is the purpose of this booklet to explain in simple terms to non-technical readers the functioning of the fuel injection equipment, how to prevent faults from developing and how to achieve the rectification of faults that are within the scope of the boat owner. Major repairs, complete overhauls and testing require special equipment and the specialised knowledge of a fully trained diesel fitter. Such tasks are the province of a shore-based diesel workshop and should never be attempted without the necessary facilities and training.

THE DIESEL ENGINE

The diesel engine itself is mechanically quite simple and has a similar arrangement of pistons, cylinders, valves, connecting rods, crankshaft and crankcase as the petrol engine in the modern motor car. Considering only the four stroke engine for the sake of simplicity, the diesel cycle is identical to the petrol engine cycle in that it, too, comprises inlet, compression, power and exhaust strokes. At this point the similarity ends, for in place of the carburettor, coil, distributor and sparking plugs of the petrol engine, the diesel engine has a fuel injection pump and fuel injectors.

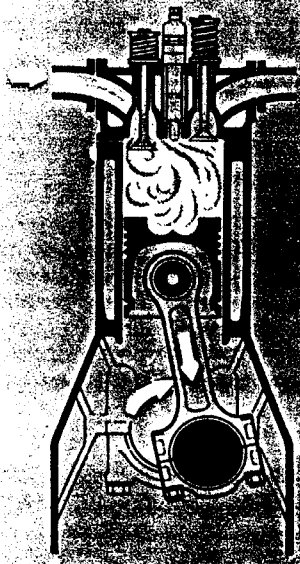

1 Inlet stroke. Air is drawn into the cylinder.

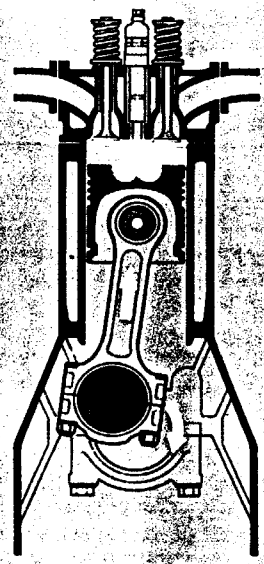

2 Compression. The air is compressed and becomes hot.

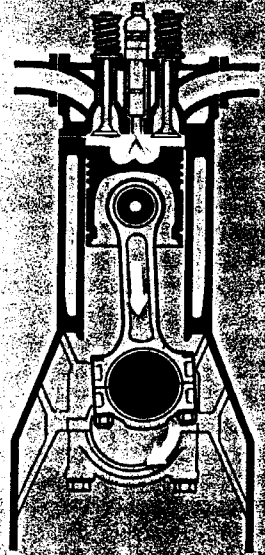

3 Power. Fuel is sprayed into the hot air, ignites and burns. The high pressure forces down the piston.

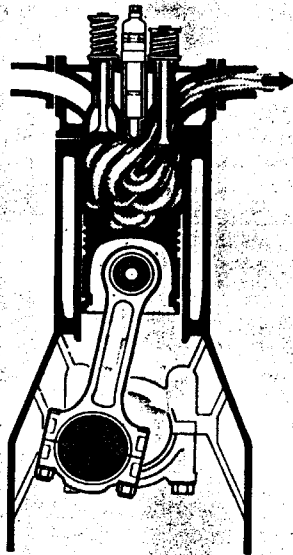

4 Exhaust. The burnt gases are evacuated.

Fig. 1

The fuel used on modern high speed diesel engines is known in Britain as DERV (Diesel Engined Road Vehicles), or in Europe and America as GAS-OIL. It is an almost colourless liquid that does not vaporise at ordinary temperatures. It cannot therefore form an explosive mixture of fuel and air as does petrol, but is burned in the engine by being forced into the combustion chamber as a very fine spray. The air, which naturally contains the oxygen required for combustion of the fuel, is first drawn into the engine cylinder on the inlet stroke of the piston and then rapidly compressed by the return (compression) stroke of the piston to a pressure which varies between 450 to 700 lbs per square inch according to engine type. The average pressure is around 550 lbs per square inch. The air is heated to a temperature in excess of 1000 F by this rapid compression, a phenomenon familiar to anyone who has held the bottom of a bicycle pump when inflating a tyre in a hurry, and the heat is sufficient to ignite the fuel spray when injection takes place. This is the characteristic feature of the diesel.

Illustrated in Fig 1 are the sequence of events which together provide the four strokes of the diesel cycle. First the inlet stroke. The piston starts to move downwards in the cylinder, the inlet valve opens and air is drawn in. The inlet valve closes at the end of the piston stroke.

Second, the compression stroke. Both valves are closed and the piston moves upwards, compressing the air in the cylinder and heating it to a high temperature.

Third, the power stroke. Just before the piston reaches the top of the compression stroke, the fuel is injected into the combustion chamber in a finely atomised spray. The temperature of the compressed air is sufficient to ignite the fuel, which burns rapidly. The resulting high pressure, generally around 1100 lbs per square inch, forces the piston downwards thus providing power.

Fourth, the exhaust stroke. Towards the end of the power stroke, the exhaust valve opens, and the piston again moves upwards, pushing out the combustion gases ready for a fresh charge. The exhaust valve closes and the cycle is repeated.

THE FUEL SYSTEM

In order to inject fuel into the combustion chamber when the air is compressed to high pressure, the fuel must be under still higher pressure. This pressure is developed by the fuel injection pump, a compact unit made with very great precision and which is usually fitted with a governor to enable the speed and power of the engine to be controlled automatically.

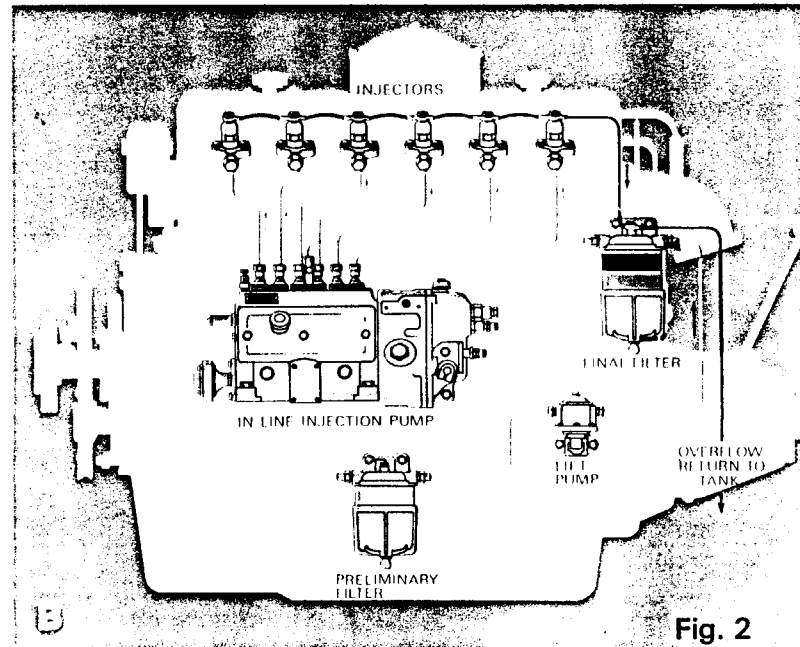
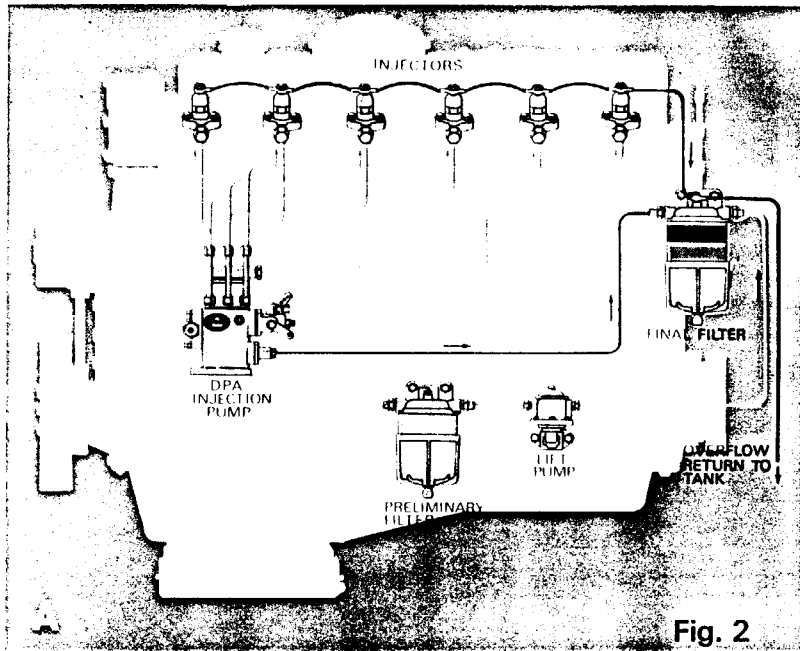

The fuel is sprayed into the combustion chambers by means of injection nozzles which are positioned and held in place by nozzle holders. The complete unit of nozzle and holder is known as an injector and there is usually one injector for each engine cylinder.

Typical fuel injection systems are illustrated in Figs 2A and 2B. Here the equipment is shown fitted to a six cylinder marine engine with fuel transferred to the injection pump by means of a lift or feed pump. Note that on its way from tank to injection pump, the fuel passes through filters. These are a very important part of the fuel injection system as will be explained later.

The injection pump is driven from a suitable shaft or gear train on the engine and is carefully set or 'timed' to inject fuel at precisely the required instant during rotation of the engine crankshaft.

Two types of fuel injection pumps manufactured by CAV and illustrated in Fig 3 are in general use on marine diesel engines of the type described in this booklet. These are the in-line multi-cylinder pump and the modern compact DPA or distributor type pump.

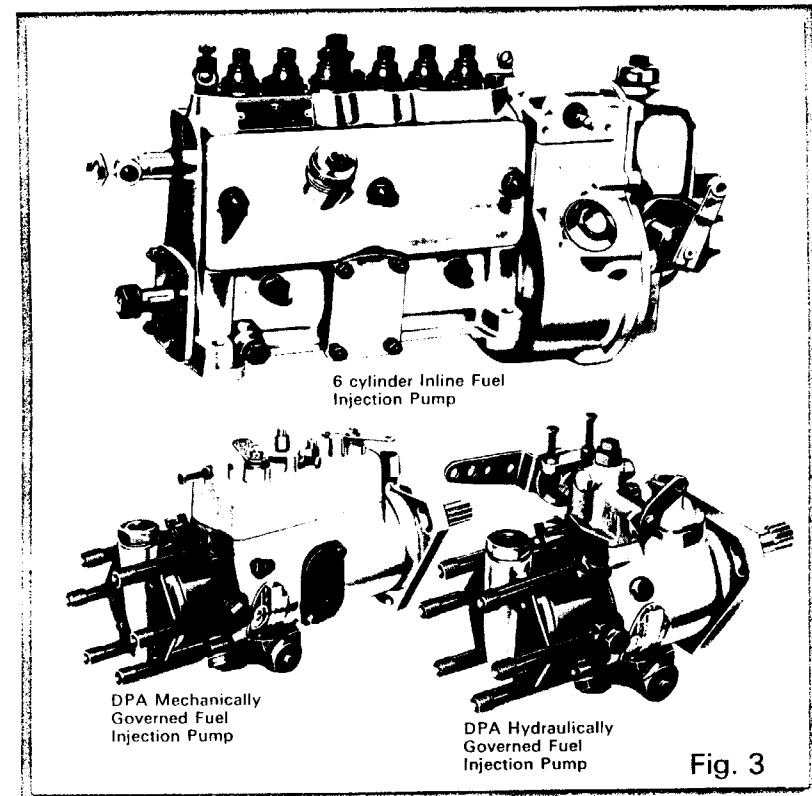

THE IN-LINE INJECTION PUMP

Let us first look at the operation of the in-line pump. Fig 4 shows a very much simplified arrangement of an in-line pump and injector. Here the pumping plunger of a simple injection pump is operated in the pump barrel by means of a return spring, cam, and cam roller. Fuel is fed from the fuel tank to the pump plunger by the feed pump. The cam rotates (driven by the engine), the return spring forces the plunger down so that the cam roller follows the cam profile, and as the plunger moves downward, the space above the plunger is filled with fuel.

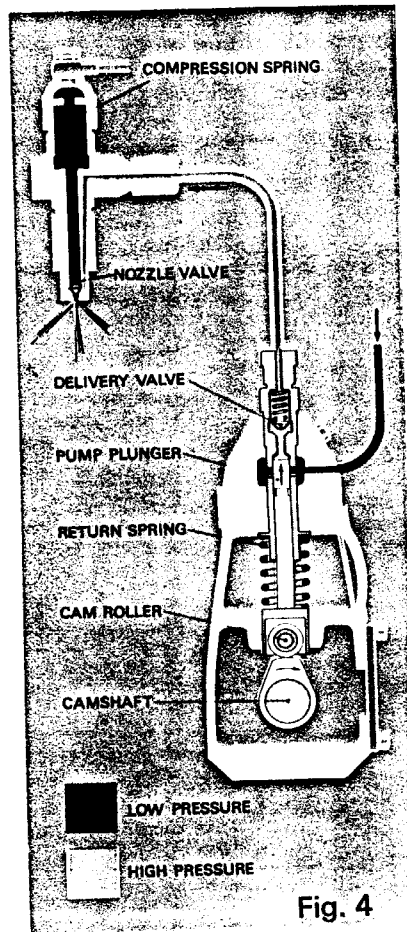

As the cam continues rotation, the plunger begins to move upwards and, at a certain point in its travel, the top of the plunger closes the fuel inlet thus trapping the fuel above the plunger and forcing it up and out of the barrel. The outlet from the pump barrel is normally closed by a spring-loaded valve known as the delivery valve. Its purpose is to ensure that the injection pipe lines are kept full of fuel and that none of this fuel is drawn into the pump on the plunger filling stroke. As the plunger pumping stroke continues, the fuel under pressure lifts the delivery valve and is forced out towards the injector.

The in-line pump, just described in very simple terms, uses a separate pumping element for each engine cylinder; each element consisting of a plunger and barrel together with a suitable means of controlling and varying the output. The pumping elements are operated by individual cams carried on a single engine driven internal camshaft. This ensures uniformity of delivery and timing of the injection of fuel.

THE DPA PUMP

The DPA or distributor type pumps shown in Fig 3 differ both in construction and method of injection. Although the pumping of fuel is produced by cam operated plungers forcing fuel along a pipeline to the injector, this is the only similarity to the in-line pump.

In the distributor pump there is one pumping element which rotates inside an internal cam ring. The fuel to and from this pumping element is fed through a rotor or distributor which connects the pump delivery to each injector in turn.

Consider the simplified illustration Fig 5. Here can be seen both the pumping section and the distribution section of the pump rotor. The pump rotor is a very accurately machined rotating fit in a stationary steel cylindrical body called the hydraulic head. The pumping section of the rotor is larger in diameter than the distributing section and has a transverse bore or cylinder containing two opposed plungers; these are the pumping plungers.

As the rotor turns, one of the inlet ports in the rotor aligns with the inlet port in the hydraulic head. Fuel under moderate pressure (30 to 80 lbs per square inch dependent upon pump speed) enters the rotor, passes down the central passage and into the space between the plungers, so forcing them apart. (Note that in this type of pump there are no springs operating the plungers.) This is the inlet stroke. As rotation continues the inlet port is closed and the radial distribution port in the rotor aligns with an outlet port in the head. Simultaneously

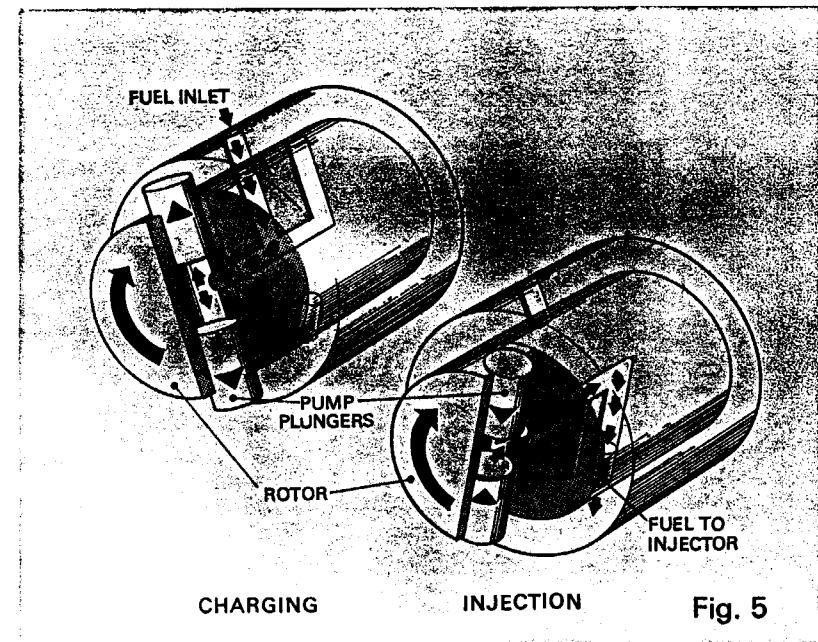

the plungers are forced together by the cam lobes on the cam ring and the fuel is expelled at high pressure to one of the injectors. This is the pumping or injection stroke.

The ghosted views, Fig 6, further illustrate the functioning of the distributor rotor. The charging view shows the rotor in the inlet position. The cam rollers are off the cam lobes, allowing the plungers to be forced apart by the metered volume of the incoming fuel charge. The inlet port in the hydraulic head is in register with one of the charging ports in the rotor (four, in this illustration) while the rotor distributor port is well out of register with the discharge ports in the hydraulic head which lead to the injectors.

With further rotation of the rotor the relative positions change until the injection point is reached (injection view Fig 6). Here the rollers are on the slopes of the opposite cam lobes, so forcing the plungers together and discharging the fuel through the distributor port in the rotor which is in register with one of the fuel outlets. At this point, the charging ports are out of register with the inlet port in the hydraulic head.

As rotation of the rotor continues, the charging and injection cycles are repeated in sequence, with the rotor alternately charging through each inlet port in turn and discharging into each successive outlet in turn. The number of inlet ports on the rotor and outlet ports in the head correspond to the number of cylinders on the engine to which the pump is fitted, ie, four on a four cylinder engine, six on a six cylinder engine.

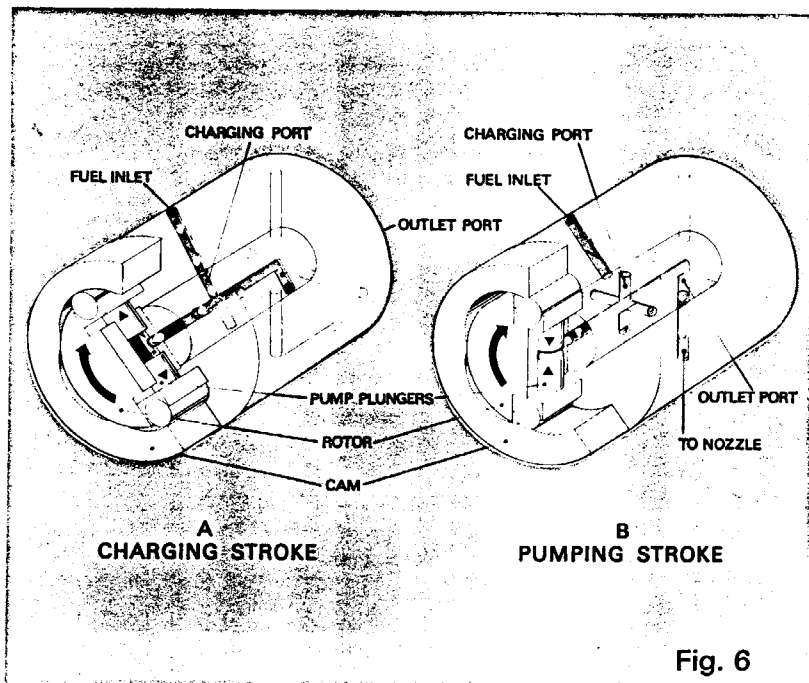

Fig. 6

THE INJECTOR

The preceding description of the diesel fuel injection pump explained how the pump delivers a charge of high pressure fuel at the correct instant of time. To ensure that fuel reaches the combustion chamber of each engine cylinder in a form suitable for proper combustion so that the engine can deliver its correct power, an injector is necessary for each cylinder.

What is an injector? Basically it is an atomiser or sprayer consisting of a nozzle and a nozzle holder so secured to the engine as to form a gas-tight seal in the cylinder head of the diesel engine. The CAV injectors described here are of the modern type which incorporate a valve. This type is known as a 'closed' injector and is responsive to the fuel pressures produced by the fuel injection pump. When the injection fuel pressure is raised above a predetermined level, the valve opens and stays open until the pressure drops. The fuel injection system is so designed that the valve has a 'snap' action in opening and closing to ensure very accurate timing and delivery of the fuel. Fig 7 shows a simplified diagram of an injector.

The spring-loaded valve is operated hydraulically by pressure from the fuel itself. Fuel entering the injector passes through galleries drilled in the body and nozzle, down to a spherical chamber surrounding the nozzle valve in the nozzle tip. Pressure of the valve spring holds the valve tightly closed until, on the injection stroke, fuel pressure rises almost instantaneously to above the preset spring pressure. This fuel pressure, acting upon the tapered shoulder of the nozzle valve, lifts the valve against its spring loading, thus permitting the high pressure fuel to spray through the drilled hole or holes in the nozzle tip. The movement of the valve is influenced by the effect that, as the valve lifts off its seat, a larger area is exposed to fuel pressure and opening is accelerated.

At the end of the fuel injection stroke the fuel delivery pressure falls very quickly and the valve spring returns the valve to its seat, thus abruptly terminating the fuel injection spray into the engine cylinder.

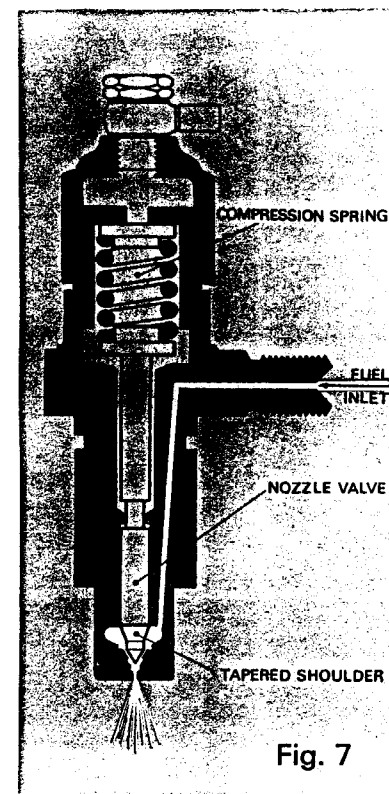

Fig. 7

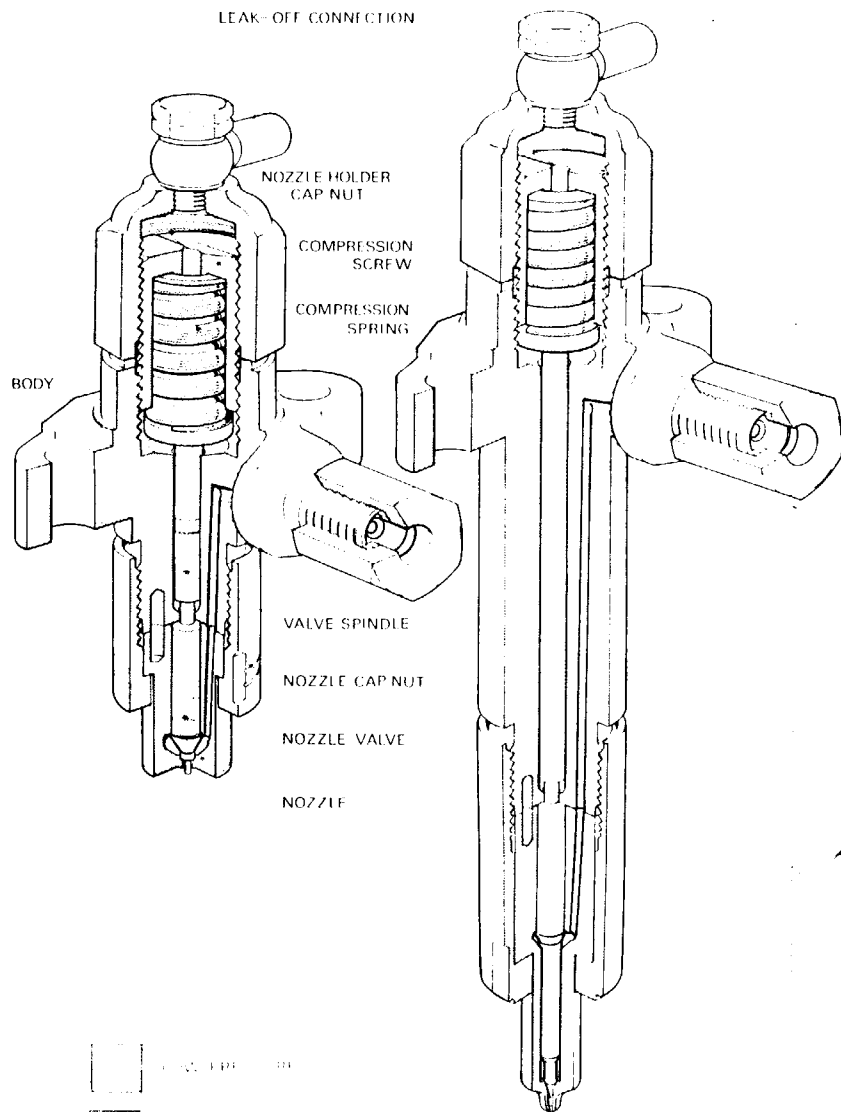

Fig. 8

The sectioned views of two CAV injectors in Fig 8 show that the actual injector is much more complex in construction than indicated in the simplified drawing but the operating principle is exactly as described. The injector on the left is fitted with a conventional CAV Single Hole nozzle. On the right is an injector with a CAV Long Stem nozzle and other than basic differences in size and shape, the real difference is in the valve design. The nozzle valve itself has an elongated stem machined so that it is a clearance fit in the extended body of the nozzle. Two tapered shoulders are formed on the valve stem to provide differential lift of the valve for specific injection characteristics. Extending the valve stem also raises the close-fitting part of the valve to a point in the cylinder head where it can be cooled and the valve is protected from the high temperatures that exist around the nozzle tip under operating conditions.

The form of spray produced by the nozzle is a vital part of the design of any particular diesel engine and to cater for these individual requirements there are several types of nozzles, each of which has its own particular advantages depending upon the required spray characteristics. CAV nozzles in common use may be grouped into three main types: Single-hole, Multi-hole and Pintle. Variants of these basic types are required for specific applications so the Multi-hole is available as either short or long stem types and the Pintle nozzle is used in three forms, ie, Pintle, Delay or Pintaux. The individual spray characteristics of these nozzles are illustrated in Fig 9.

Although a range of nozzles of varying characteristics is available it does not mean that the types are interchangeable at will, or that experiments with different nozzles are in order. On the contrary, it cannot be emphasised too strongly that the specification of the particular nozzle type fitted to your engine and its setting of opening pressure is the result of careful collaboration between the engine designer and the fuel injection equipment manufacturer. Any change, unless authorised by the manufacturer, will almost certainly have a detrimental effect on the performance and efficiency of the engine.

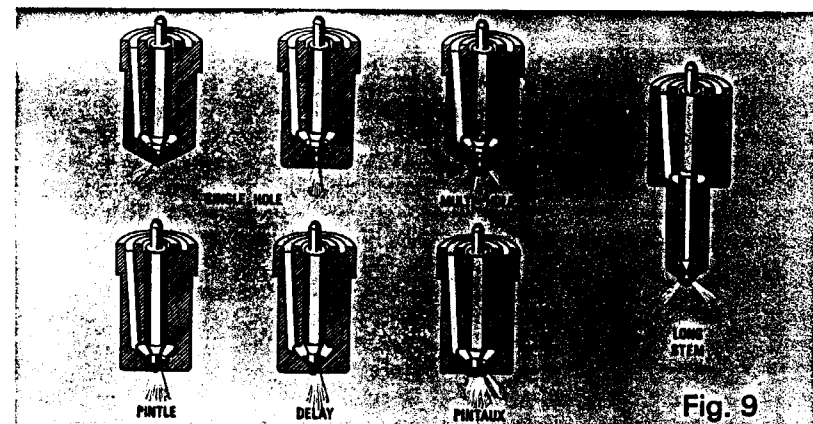

Fig. 9

Earlier sections of this booklet have explained, in simple terms, how the injection pump delivers a charge of fuel to the injectors. Just consider for a moment the exacting task of the pump. It has to pump a charge of fuel that may be smaller in size than a pin-head, at pressures that can rise almost instantaneously up to 9,000 lbs per square inch, it has to repeat this operation hundreds of times per minute with unerring accuracy and the amount of fuel injected must be under the instant control of the throttle or the governor. The pumping plungers are quite small and they are engineered to fit their housings perfectly. The fit and finish are the finest that modern engineering can provide; machined to accuracies of around four one hundred thousandths of an inch (0.00004 inches). Since these parts operate in fuel oil, wear is negligible, *unless* dirt or water gets in the fuel. When that happens, just imagine the effect of abrasive grit on those finely machined surfaces when the fuel pumping pressure is in the region of four tons to the square inch. Water, too, is equally injurious to the pump. It causes corrosion and rusting of the working surfaces and springs.

Research by the manufacturer has shown that the critical parts of a pump subjected to wear caused by dirt in the fuel, are the pump plunger and barrel of an in-line pump, and on the distributor type pump; the rotor and hydraulic head bore, and the pumping plungers and their bore. Wear in any of these regions causes leakage of fuel to the low pressure side of the pump during injection, thus reducing the quantity of fuel injected. These leakage losses are greater at low engine speeds—there being more time during the injection stroke for the fuel to leak by—and the ultimate effect of wear is that the delivery at cranking speed is inadequate and the engine cannot be started. Leakage increases rapidly with wear (leakage between two surfaces is proportional to the *cube* of the distance between them) and if as little as 0.00012 inches is worn away from the mating surfaces in the critical parts of the pump, the pump may be completely inoperative.

Now you can see how important it is to keep the fuel clean. Any abrasive dirt carried into the pump with the fuel will scuff and score the working surfaces—even the finest dust will damage the fine surfaces beyond repair. Worn components mean inefficient pumping, irregular deliveries to the various cylinders, bad running and poor starting.

The injector nozzles, too, can suffer damage from dirt or water in the fuel. The nozzle valve is engineered to the same incredible accuracies as the pump plunger, for it has to slide freely in the nozzle bore and yet ensure that the tiny volume of fuel in each high pressure charge from the pump does not leak past the valve stem. The nozzle valve must fit the valve bore and valve seat perfectly and it is held to the seat by very heavy spring pressure—valve opening pressures can exceed 200 atmospheres, over 3,000 lbs per square inch. A very small amount of fine dirt or water in the fuel can cause sufficient scuffing, wear or corrosion to upset the nozzle entirely, with consequent poor starting, uneven running or smoky exhaust.

The fuel oil filters and sedimenters fitted between the fuel tank and injection pump are provided to prevent this wear. Gauze filters,

however fine, are completely useless for diesel work and a good modern filter is essential. Continuous progress in research and design has led to the almost universal choice of a specially impregnated paper as the best fuel oil filtering element.

The 'FS' filter shown in Fig 10 is one of the CAV range of modern high efficiency fuel oil filters. It is compact, fits in the fuel line between feed pump and injection pump and is suitable for engine or bulkhead mounting. Instead of the more usual filter bowl containing an element, the element casing itself forms the bowl. The filter unit consists of three main parts: the filter head, the element and the base. The filter being of the cross-flow type, inlet and outlet connections are carried on the filter head which also incorporates the mounting bracket. Both space and weight are saved by dispensing with the conventional filter bowl and element replacement is simplified to unscrewing one bolt.

The direction of fuel flow in the illustration of the 'FS' filter takes advantage of the fact that the paper filter element is specially designed for the dual function of filtration and agglomeration.

Fuel oil flows into the element from the top; solid particles are retained within the filter element, and any fine water droplets held in suspension in the fuel are forced through the pores of the filter element.

This takes advantage of the fact that when fuel containing very small water droplets is passed through a porous medium the water droplets will join together, or agglomerate, and form larger droplets which will sink to the bottom of the fuel container under the influence of gravity; the rate of sedimentation depending upon the size of the droplets.

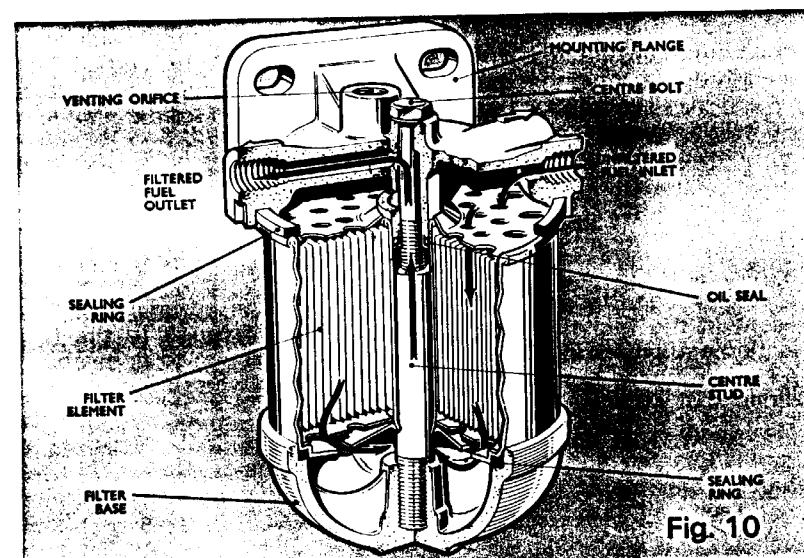

Fig. 10

The large water droplets thus formed separate out from the fuel oil by sedimentation into the base of the unit. The clean fuel then passes up the central tube of the filter element to the outlet in the filter head.

Water in diesel fuel can be quite a problem to the marine diesel engine user. We have already described the effects of corrosion, wear and pitting of highly finished components and possible spring breakages that can arise from water entrapped in the pump or injectors. Let us now look into the question of how the water gets into the fuel.

Water is everywhere; even the dry desert air of the Sahara contains water vapour which may be condensed out by lowering the temperature. Anyone who has ever defrosted the domestic refrigerator knows that lowering the air temperature will condense out water vapour. So too with diesel fuel; a certain amount of dissolved water is present, in concentrations up to 0.05% depending on the type of fuel, the temperature and the humidity of the air in contact with the fuel. As long as this water remains dissolved in the fuel, all is well, for as far as is known, dissolved water is harmless, it is the free water in droplet form in the fuel that is dangerous.

This free water gets into the fuel in several ways. It may be deposited from solution with a fall in temperature, or it can be condensed from the air in either the bulk storage tank or the vessel's own fuel tanks. Accidental introduction of water during refuelling or water drawn in through the vessel's fuel tank vents as a result of pressure fluctuations caused by fuel movements within the tank are additional ways for water to get into the tank.

In general, the fuel supplied by the oil companies and dispensed from fuelling barges or bulk installations contains little or no free water and regular checking of bulk installations and tanker vehicles is carried out to ensure this. However, there are exceptions, and it is not generally appreciated that in a 1,000 gallon tank as much as 5 gallons of water may accumulate in a year by condensation from the air and by precipitation from solution in the fuel.

This figure is for a shore based storage tank subjected to the normal temperature differences that occur between day and night. In a vessel whose fuel tank is in the engine room and therefore subjected to quite high temperature variations, the figure could be even higher.

It can be seen that even when great care is taken, water can still be present in the fuel tanks and thus be carried through to the fuel injection equipment in damaging quantities. What can be done about it? The answer to this problem is to remove the water from the fuel by means of water separators fitted in the fuel line.

Designed specifically for this purpose is the CAV 'Filtrap 120' illustrated in Fig 11. It is designed and engineered as a primary separator capable of removing water and damaging solid particles from diesel fuel. It replaces the gauze, paper or felt preliminary filter normally used to protect the feed pump and has the advantages of

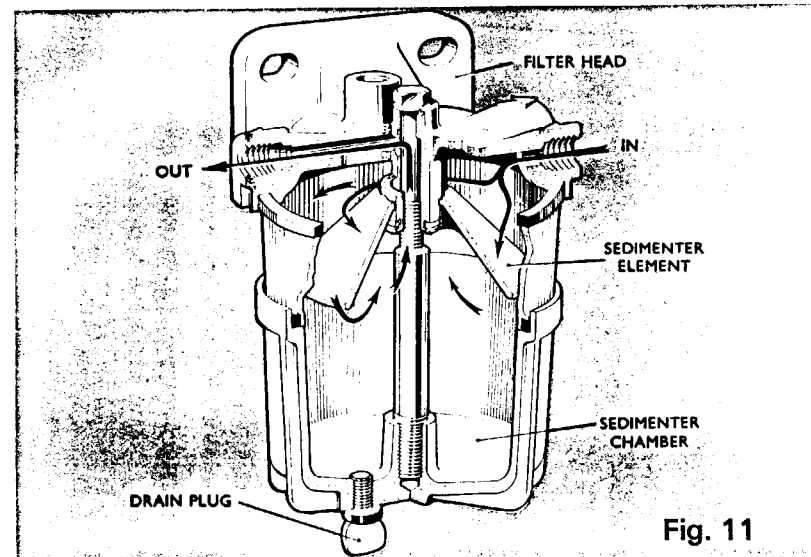

Fig. 11

constant low resistance to flow and freedom from choking. This means that performance is predictable and consistent and that effective operation is assured even at low ambient temperatures, where wax starts to come out of solution in the fuel.

The unit is in three parts: a head, a conical element and a collecting bowl. They are fabricated in robust aluminium die-castings and a thumb screw in the base of the sedimenter allows the accumulated water and sediment to be drained or flushed away as required. Ingenious design gives the maximum possible sedimentation for its size and the unit works as follows.

Fuel flows through the inlet connection and enters the body of the sedimenter. It then flows over and around the conical section of the element, which acts as a diffuser to the fuel flow, and passes through a narrow gap around the periphery of the conical section. The fuel then flows radially towards the centre and out through one of the outlet connections. During this period of radial flow, the particles of solid matter and water, being heavier than fuel oil, separate out under the influence of gravity and are deposited within the collecting bowl. Maximum possible sedimentation is achieved by this radial flow which uses the whole area of the sedimenter.

A bypass air bleed is drilled into the outlet connection at the top of the sedimenter to release air which may have been carried into the sedimenter with the fuel. Any very small air bubbles which are carried round with the fuel into the lower chamber will rise to the under surface of the cone and pass out with the fuel. Thus, by means of a bypass air bleed and a conical element with a central outlet, air or vapour accumulations are prevented. This ensures that the unit is completely filled with fuel and prevents the remixing of the separated

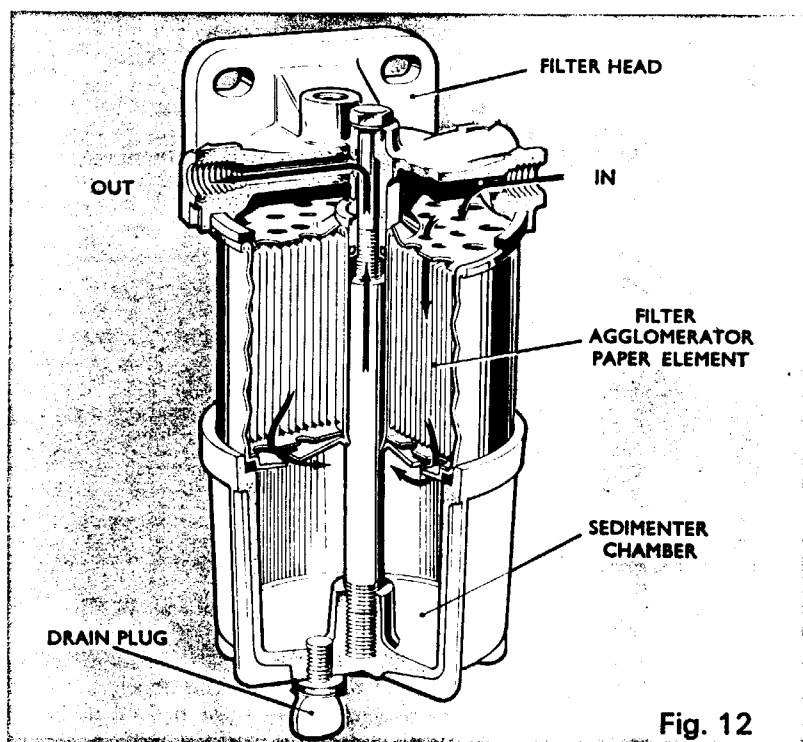

Fig. 12

water and sedimented deposit as a result of engine vibration or vessel movement. It is a feature unique to the CAV sedimenter and vitally affects the performance of the unit.

The 'Filtrap 120' should be positioned in the fuel line before the feed pump to ensure that the water particles are not broken up by the action of the feed pump and in this location well over 90% of suspended water will be removed from the fuel. The unit will operate successfully up to a recommended maximum fuel flow of 10 gallons per hour, and a larger fuel flow may be catered for by connecting two or more units in parallel. As a guide to requirements it may be assumed that 10 gallons per hour is approximately the *full load* fuel flow of a 12 litre capacity (723 cubic inches) diesel engine. Even at the maximum recommended fuel flow, particles of solid matter larger than 100 microns (0.004 inches) will be separated from the fuel. Water droplets larger than 300 microns (0.012 inches) are effectively sedimented at the fuel flow of 10 gallons per hour and at lower fuel flow rates even smaller solid particles and water droplets are consistently sedimented.

This preliminary filter does not, and is not intended to, act as substitute for the final filter. Its function in the fuel system is to remove the larger particles of water and dirt and so protect the feed

pump and also extend the service life of the final filter. A final filter *must* be fitted in the fuel line between the feed pump and the injection pump and it must contain a filter element capable of removing solid particles of sizes that would cause damage and wear to the injection pump and injectors.

In the CAV filtration system either the 'FS' filter or the 'Filtrap 100' shown in Fig 12 can be used as the final filter. Although basically similar in principle to the 'FS' filter already described the 'Filtrap 100' is specifically designed to function as a combined filter and agglomerator-sedimenter. It operates in the following manner.

The fuel, containing fine water droplets which have passed through the 'Filtrap 120' sedimenter is emulsified by the action of the feed pump and flows into the top of the filter element. This element is specifically designed for the dual function of filtration and water separation. The fuel flows downward through the element, the fine texture of which retains the solid particles in the normal manner. The fine water droplets forced through the pores of the filter element coalesce, or agglomerate, into larger droplets which are deposited by sedimentation into the large sedimenter chamber in the base. The fuel, free of solid particles and water, flows up the centre tube of the element to the outlet connection in the head. The accumulated water may be drained off from the base by means of the drain plug provided, without the necessity of dismantling the equipment. Element replacement is equally simple. The assembly bolt in the head is unscrewed, the element and bowl removed and the element discarded.

This 'Filtrap' system provides a standard of fuel oil filtration comparable with the best yet devised and the water-separation system gives the finest possible protection to fuel injection equipment even under the most unfavourable marine conditions.

SERVICING

The modern high speed marine diesel engine, together with its fuel injection equipment, is a carefully designed and engineered power system. All the individual parts of this system are equally important when considering the reliability and performance that is required in marine use.

Much can be done, with little effort by the boat owner, to ensure that the precision fuel injection equipment is maintained in first-class condition and allowed to give the long service life that it is designed to provide. In the main, this kind of maintenance is based upon cleanliness and common sense. Previous pages of this booklet have explained in non-technical terms the workings of the equipment and have shown the need to ensure that nothing but clean fuel reaches the pump and injectors. Dirt, water and corrosion are the basic causes of faults developing, so much so in fact, that if right from the start the owner gets rid of dirt and water in the fuel, then 90% of potential engine troubles will be avoided.

The equipment so far discussed has been the injection pump, injectors and filters. Let us now see what can be done by the boat owner in maintaining this equipment in first-class order.

THE INJECTION PUMP

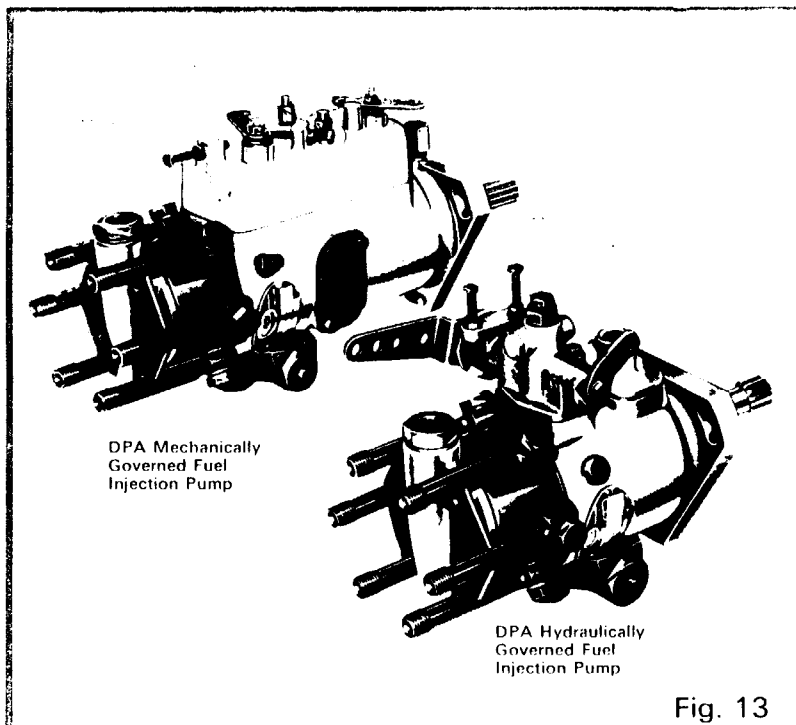

Fig. 13

Whether the fuel injection pump is a CAV in-line or a CAV distributor type DPA pump, maintenance is simple and easy. Keep the pump clean and free from leaks, and you are home and dry. Check that the high pressure connections are firm and leak-free and that there is no distortion of the pipes that could put strain on the connections.

On CAV in-line pumps the internal camshaft runs in oil in the cambox in the same manner as the engine crankshaft runs in oil in the sump. Early model pump camshafts were lubricated with fuel oil back-leaked from the pump plungers, but with the modern highly rated pumps, camboxes are initially provided with the same lubricating oil as the engine. With constant use this oil in the injection pump becomes diluted with back-leakage fuel oil from the pump plungers and therefore at 100-hour service intervals the pump cambox should be drained of oil and refilled with fresh engine oil to the level recommended by the pump manufacturer. This level is indicated

either by a dipstick fitted to the pump or on certain models by means of an oil level plug.

This type of lubrication maintenance is not required on the DPA pump. The pump is entirely filled and lubricated by its internal pressurised fuel oil.

No adjustments or changes in setting can be made to either type of injection pump without the use of a special test machine, the relevant technical data and the correct technical training. However, if the engine persistently stalls when idling, the slow running or idling screw may be set to the desired position by the boat owner. Fig 13 illustrates the position of the idling stop screws on the hydraulically and mechanically governed DPA pumps. Refer to the engine manufacturer's handbook for the idling stop on the in-line pumps.

THE INJECTORS

Injectors should be removed and serviced at regular intervals to prevent trouble and the frequency of this service interval depends upon the degree of fuel oil filter maintenance, combustion conditions in the engine and engine operating conditions. Many engine manufacturers give recommended service intervals for the injectors and these recommendations should be followed where possible but in the absence of specific data a figure of 900 hours operation between servicing is a useful guide for the boat owner.

The nearer the ideal conditions of good combustion with adequate cooling and absolutely clean fuel are realised, the less attention the injectors will need, and so the longer their effective life. Since the efficiency of the injectors vitally affects the performance of the diesel engine, it will repay the boat owner handsomely to see that the engine never runs with any of the injectors out of order.

The first symptoms of injector trouble usually show themselves as one or more of the following faults: excessive cylinder knock, engine overheating, loss of power, difficult starting, black smoky exhaust or increased fuel consumption.

Do not immediately assume that the injectors are the sole cause of such symptoms, for such other defects as faulty engine valve timing, badly leaking engine valves, incorrect pump timing, dirty or damaged fuel filters, wrong fuel, water in fuel, defective engine lubrication, 'hot' bearings or incorrect injection pump maximum fuel settings could cause similar signs of distress.

Assuming, however, that everything else is in good order, the particular injector, or injectors, causing the trouble can often be pinpointed in the following manner.

Run the engine at fast idling speed and one at a time, slacken off the high pressure pipe union nut on each injector. This will cut off the fuel delivery to the injector and if the injector is in good working order, the engine revolutions will change. No change, or very little change, indicates a faulty injector. Retighten the high pressure pipe union nut and repeat the test with each injector in turn until all injectors have been checked. Stop the engine after all the injectors have been checked.

Having located doubtful injectors in this way, a confirmatory visual test may be made if desired. Uncouple the particular high pressure pipe union both at the doubtful injector end and at the pump end and then remove the injector from the engine. Re-couple the injector to the pipe as shown in Fig 14 so that the injector is pointed nozzle outwards in order that the spray can be examined. Tighten the pipe union on this injector then re-couple the other end of the pipe to the pump. *Slacken* the pipe unions on all the other injectors to prevent the engine from starting.

Motor the engine around with the starter motor until the injector nozzle sprays fuel into the air when it can be seen at once if the spray is in order. **CAUTION** *Because of the extremely high pressures involved, the direct spray from a nozzle can easily penetrate the skin and fuel oil in the bloodstream is dangerous. Therefore, keep the injector turned away from the skin and on no account allow your hands to be in contact with the spray.*

If the spray is unduly 'wet' or 'streaky', obviously to one side, or if the nozzle dribbles, then stop the engine, disconnect the faulty injector and replace it with a new or reconditioned injector properly fitted to the engine. Do not forget to retighten any loosened fuel connections. After fitting the new injector, the faulty injector should be wrapped in greaseproof paper or cloth for future reconditioning by the diesel workshop at the service agency.

It is not possible for the owner or crew to recondition or service an injector without the essential nozzle setting outfit, special tools, technical data and service training. Any tinkering or attempts at servicing without these essentials will always make matters worse.

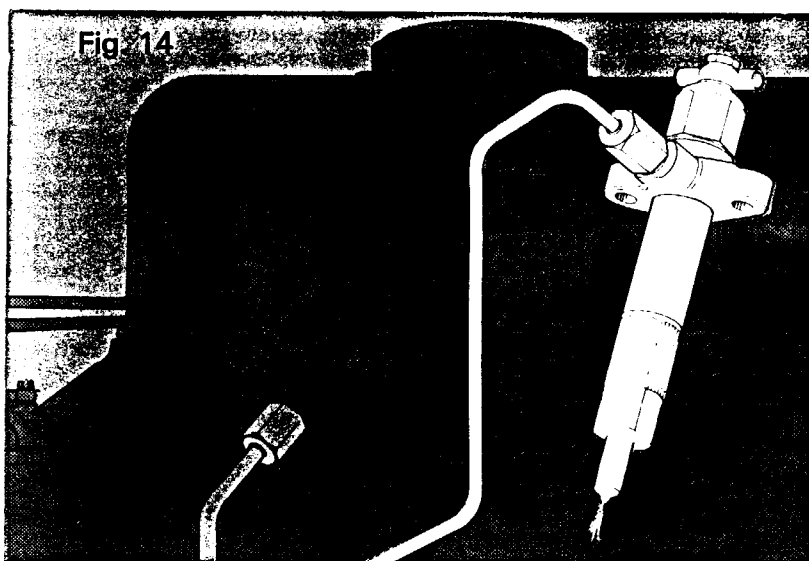

CORRECT INSTALLATION OF INJECTORS

The injector mounting hole in the cylinder head must be free from dirt and carbon. This is particularly important at the point where the injector seats in the hole in order to ensure a gas-tight seal and effective heat transfer from the injector to the cylinder head.

Certain engines have a seating washer between the injector and cylinder head and this should always be removed when detaching the injector. It is equally important to renew this washer when fitting the injector. Failure to fit a washer would result in gas blow-by and overheating of the nozzle because of the poor metal to metal contact between injector and cylinder head. Overheating would eventually lead to nozzle valve seizure. Accidental use of two seating washers, as could happen if the original washer was not removed when withdrawing the injector, would result in the nozzle not protruding far enough into the combustion chamber. This could cause the fuel spray to impinge on the wall of the combustion chamber, thus resulting in incomplete combustion giving reduced power and a smoky exhaust.

Other engines are provided with a copper sleeve or insert in the injector hole and therefore do not require a washer for seating the injector. If you do not know, check on which type of engine you have in your craft, for if a seating washer is fitted where not required, then the nozzle of the injector will not be correctly positioned in the combustion chamber and the fuel spray will not be correctly directed into the combustion chamber.

Faulty securing of the injector to the engine can cause distortion of the nozzle body resulting in a sticking nozzle valve and rapid deterioration of the nozzle. When fitting an injector, always ensure it is squarely seated and that the clamp or securing nuts holding it down are tightened evenly with a suitable torque wrench to the correct torque values issued by the manufacturer.

THE FUEL PIPES

The high pressure pipe lines are made from high grade steel, for they have to contain fuel that is being pumped at many thousands of pounds pressure. The lengths and bore sizes of pipe vary from one engine to another and indeed on any engine no two of the high pressure pipes from injection pump to injectors are alike. It is of very great importance that if a new pipe is fitted for any reason, the replacement pipe must be identical in all respects to the original pipe fitted by the engine manufacturer. It is not generally realised that a change in length of a high pressure pipe can alter the injection timing of that particular cylinder by as much as two crankshaft degrees per foot of change, and such a change would affect engine performance.

Another point to bear in mind concerns the banjo bolts at the injection pump outlets. On certain engines fitted with a CAV DPA pump, these contain a non-return valve and care must be taken to fit the correct replacement. On these particular engines casual use of a standard banjo bolt at the pump outlets could result in changes in engine performance.

Damaged, cracked or distorted nipples caused by incorrect positioning of the pipes, or by overtightening of the union nuts, will cause fuel leaks. Remember that these joints have to retain fuel at a pressure of many thousands of pounds and that means that the joint must be perfect. If the nipple or union nut is unsatisfactory in any way, the complete pipe assembly must be renewed, for special equipment is needed to replace or reform nipples.

Always, when fitting a new pipe, offer it up simultaneously to both injection pump and injectors to ensure that the pipe fits squarely at both ends. Do not fit one end and then try to spring or bend the pipe to fit the other end. Having ensured the pipe ends are squarely fitting, then tighten the pipe unions a little at a time alternating between the pump and injector ends. Do not overtighten for this will inevitably damage the nipple or pipe. When changing an injector, always undo *both* ends of the pipe and, above all, *never bend the pipe*.

FUEL OIL FILTERS

Much has been written in the earlier parts of this booklet about the need for efficient fuel filtration. To maintain this efficiency the fuel oil filters require periodical inspection and servicing.

In view of the widely differing conditions of operation on different craft in different locations which have to be catered for, precise instructions for the time between service intervals cannot be laid down.

The period at which it will be found necessary to change the filter element varies according to the type of fuel used, conditions in the bulk storage installation at the refuelling point and the local conditions under which the engine is working. However, it is a sensible precaution to fit new filter elements at the beginning of the cruising season and a reasonable estimate of filter life would be 1,500 gallons of Grade A fuel before choking. Ideally, when changing filter elements, it is good practice to renew the filter sealing rings, 'O' rings and copper washers.

Absolute cleanliness is essential when carrying out periodical inspection and servicing of fuel oil filters. As we have pointed out, most troubles with fuel injection equipment are traceable to dirt in the fuel, and it is essential when opening fuel lines to atmosphere that the pipe ends are sealed off to keep out dirt and grit.

If the filter bowl is fitted with a drain plug, this should be removed periodically and any impurities or water drained off. Consult the engine manufacturer's manual to ascertain the periods recommended for this draining operation.

Draining off accumulated water, sludge and solid matter from the bases of the CAV 'Filtrap' units may be done at any convenient interval when the water and sludge level rises to a predetermined point. Experience dictates the interval of time required for the accumulation of water and solids but it should be understood that on no account should the water level be allowed to rise to the base of the cone in the 'Filtrap 120' or to the element in the 'Filtrap 100'.

SERVICING THE CAV 'FS' FILTER

Remove all external dirt from the assembly before attempting to service. If the system uses a gravity feed supply, turn off the fuel before dismantling the filter. Drain base if fitted with drain plug.

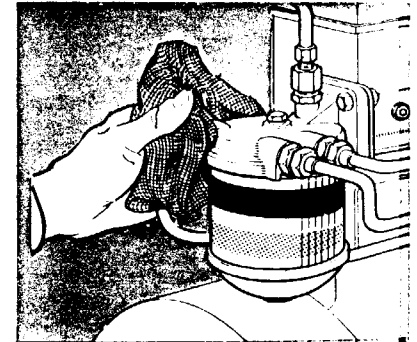

Unscrew the centre bolt and at the same time hold the filter base to prevent it rotating.

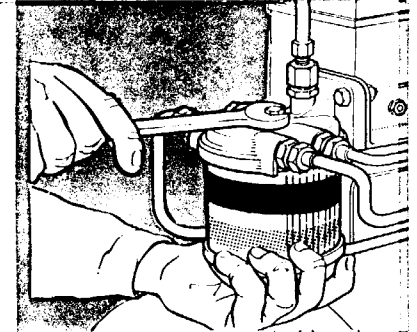

Release the filter element, complete with base, by pulling the element downwards with a twisting action so that it comes free from the internal 'O' ring.

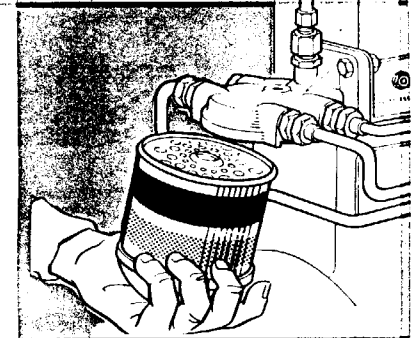

Detach and discard the element ensuring that the lower sealing ring is retained. Clean out the filter base and rinse out with clean fuel oil. Inspect the lower sealing ring for damage or imperfections and renew if necessary. If the base is provided with a drain plug, refit and tighten this plug.



SERVICING THE 'FILTRAP 120'

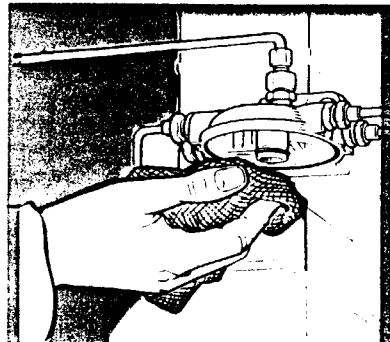

Clean inside the filter head with a clean brush or non-fluffy cleaning cloth. Pay particular attention to the groove which houses the sealing ring. Inspect the upper sealing ring and the small 'O' ring for damage or imperfections and renew where necessary. New sealing rings may be obtained from the supplier of the filter element.

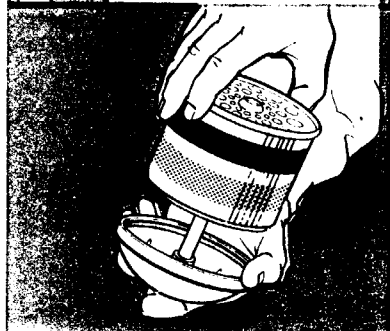

Ensure that the lower sealing ring is correctly in place on the base and then place a new filter element in position over the centre stud. The heavy rim of the element is uppermost when the element is correctly fitted.

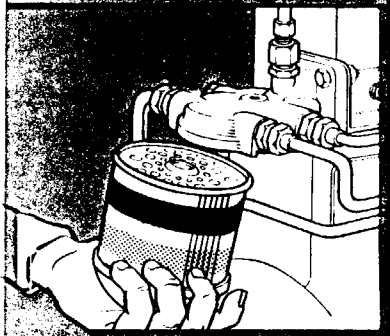

Fit the base and the element to the filter head and at the same time turn it slightly so that the element slides easily over the 'O' ring. Do not overtighten the centre bolt in an attempt to cure leaks. The bolt should be tightened to a figure of 6 to 8 lb ft torque (0.830 to 1.106 kg m).

Turn on the fuel and vent the system in accordance with the engine manufacturer's handbook and at the same time inspect the system for leaks. It is important that this operation be carefully carried out otherwise air trapped in the fuel supply side will prevent efficient working. If a handbook is not available proceed as detailed in the section headed—'Venting the system'.

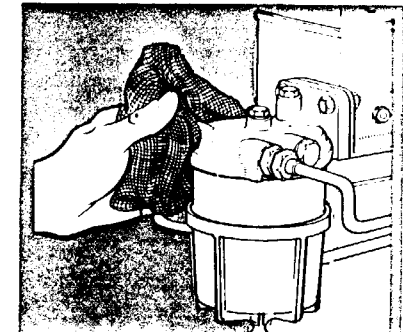

Clean off all external dirt before attempting to service the unit. If the sedimenter uses a gravity feed supply, turn off the fuel before dismantling the unit. Slacken off the thumbscrew in the base and drain the accumulated water and sludge.

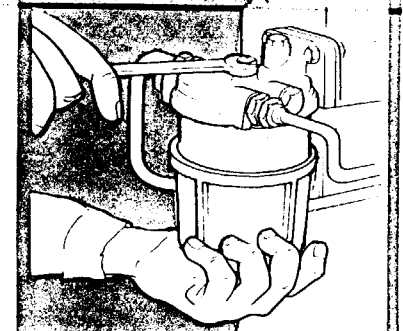

Unscrew the centre bolt and at the same time hold the base to prevent it rotating.



Detach and separate the base and sedimenter element. Inspect the centre sealing ring for damage and renew if imperfect.

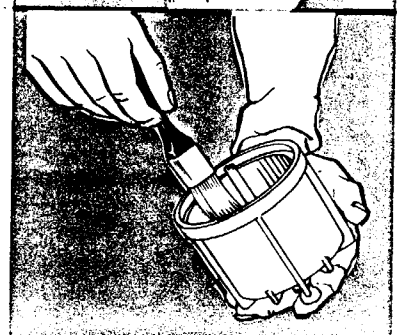

Clean the base and rinse it out with clean fuel oil. Clean and rinse the metal sedimenter element.

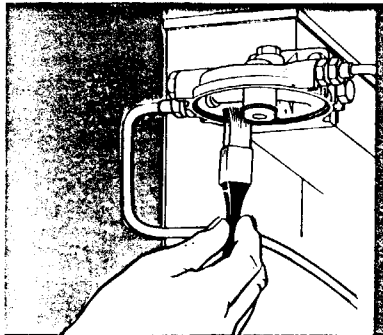

Clean out the sedimenter head and inspect the upper sealing ring for damage. Renew the sealing ring if imperfect in any way. New sealing rings may be obtained from the supplier of the filter elements.

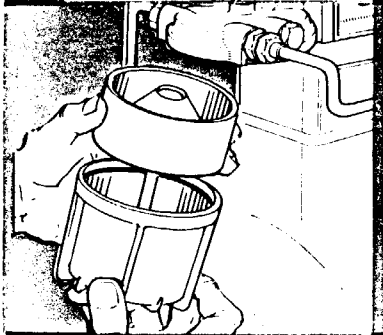

Ensure that the centre sealing ring is correctly positioned and place the sedimenter element (with cone pointing upwards) on the base.

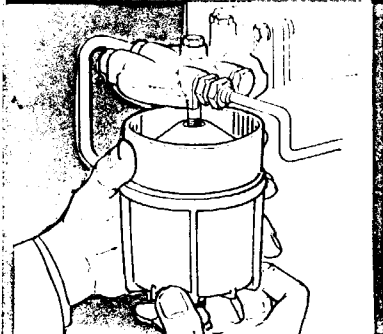

See that the upper sealing ring is correctly placed in the head and offer up to the head the assembled element and base.

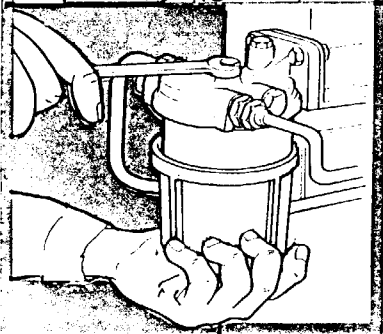

Engage the centre bolt with the centre tube and make sure the top rim of the sedimenter element is seating correctly before tightening the centre bolt to a torque figure of 6 to 8 lb ft (0.830 to 1.106 kg m). Do not overtighten the centre bolt in an attempt to cure leaks. Tighten the drain thumbscrew hand tight only.

SERVICING THE FILTRAP '100'

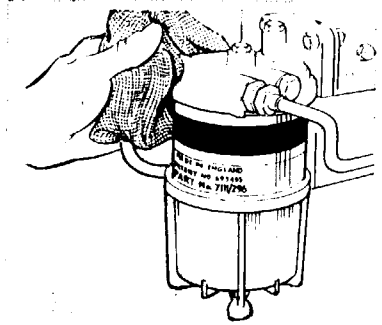

Clean off all external dirt from the unit before attempting to service. Unscrew the thumb-screw in the base and drain off accumulated water and sludge.

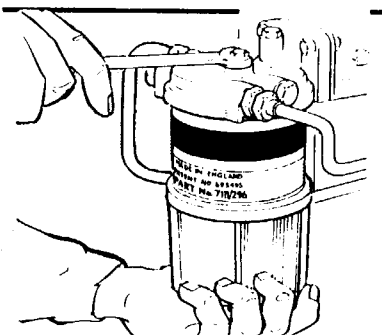

Unscrew the centre bolt and at the same time hold the base of the unit to prevent it rotating.



Release the filter element, complete with base, by pulling the element downwards and at the same time turning it slightly so that it comes free from the internal 'O' ring.



Detach and discard the element. Detach and inspect the lower sealing ring for damage. Renew the ring if defective.



Clean out the sedimenter base. Complete the cleaning by rinsing with clean fuel oil.

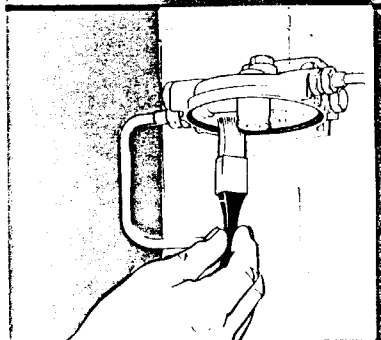

Clean the unit head and inspect both the upper sealing ring and the 'O' ring for damage. Renew any imperfect sealing ring. Replacement sealing rings may be obtained from the suppliers of the filter element.

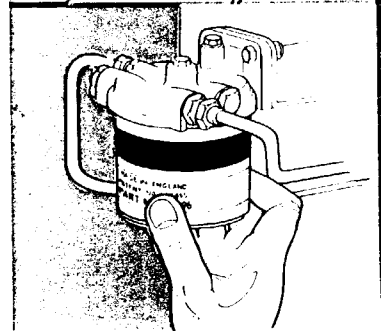

Check that the upper sealing ring and 'O' ring are correctly positioned in the head and fit a new filter element to the head. Rotate the element slightly when fitting to enable it to slide easily over the 'O' ring.

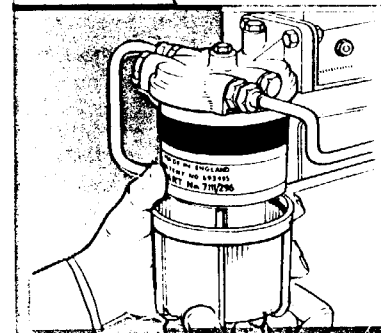

Ensure that the lower sealing ring is correctly positioned in the base and offer up the base to the assembled head and element. Guide the centre stud through the centre tube of the element and engage it with the centre bolt. Make sure that the rims of the element and base are seating correctly before tightening the centre bolt. Do not overtighten.

the centre bolt in an attempt to cure leaks. The centre bolt should be tightened to a figure of 6 to 8 lb ft torque (0.830 to 1.106 kg m). Replace and hand-tighten the drain thumbscrew.

Turn on the fuel and vent the system in accordance with the engine manufacturer's handbook and at the same time inspect the system for leaks. It is important that venting is carefully carried out, otherwise air trapped in the fuel lines will prevent efficient working. If the manufacturer's handbook is not available proceed as described in the section headed—'Venting the system'.

VENTING THE SYSTEM

The fuel injection system of a compression ignition engine depends upon very high fuel pressure during the injection stroke to function correctly. Relatively tiny movements of the pumping plungers produce this pressure and if any air is present inside the high pressure line, then this air acts as a cushion and prevents the correct pressure, and therefore fuel injection, from being achieved.

In consequence it is essential that all air is bled from the system whenever any part of the system has been opened for repair or servicing. Running out of fuel is a misfortune that also necessitates complete venting of the system before the engine can be restarted.

The following instructions for fuel system venting apply to typical systems using in-line (shown in Fig 15) or DPA pumps (shown in Figs 16 and 17) and are assumed to be fitted with filters of the CAV 'FS' or 'Filtrap 100' types. Where the actual installation differs from that shown in the illustration, refer to the engine manufacturer's handbook.

Before priming and venting, ensure that the outside of the vent screws and surrounding area is thoroughly clean to prevent dirt and foreign matter entering the system.

IN-LINE PUMPS

If the system is fed by a fuel feed pump, slacken the vent screw 'A' of the filter and operate the hand priming lever or plunger of the feed pump until fuel free from air appears from the vent plug or screw. Tighten the vent plug or screw. In a gravity fed system, turn on the fuel and then carry out the preceding instructions regarding the vent screw.

Slacken the closing plug 'B' in the fuel gallery of the injection pump at the end opposite the fuel entry and turn the engine until fuel, free from air bubbles, flows freely. Tighten the closing plug.

Open the throttle wide and slacken off any two high pressure injector pipes at the injector end. Turn the engine until air-free fuel appears at the connections. Retighten the loosened pipe connections.

The engine may now be started and run as required.

DPA DISTRIBUTOR PUMPS

The following priming and venting sequence is applicable to both mechanically and hydraulically governed DPA pumps. The only difference is the physical location on the pump of the governor vent screw 'D' and this is indicated in the appropriate illustration, Fig 16 for mechanically governed and Fig 17 for hydraulically governed pumps.

If the fuel system is fitted with a fuel feed pump, slacken both the filter vent screw 'A' and the injection pump fuel inlet union 'B', and operate the hand priming lever of the feed pump until fuel free from air issues from both the vents. Tighten both the vent connections. In a gravity fed fuel system turn on the fuel and carry out the same procedure with the vent screw and fuel inlet.

Slacken the vent valve fitted to one of the two hydraulic head locking screws 'C' and the vent screw 'D' on the governor housing. Operate the hand priming lever of the feed pump, until fuel free from air bubbles issues from the vent 'C' and then tighten this vent screw.

NOTE The space within the governor housing (vented by screw 'D') is normally filled, and its contents lubricated, by fuel oil back-leaked from the pump plungers, the pump rotor and the advance device if fitted. This is the normal way in which this space becomes filled with oil and this can naturally take a long time at feed pump pressures.

However, if the reason that the pump is being vented is because a pipe line or injector or filter element has been changed or serviced or the system has run out of fuel, then the governor housing will still be filled with fuel oil and venting by means of the hand priming lever of the feed pump will suffice. In this event, close the governor vent screw 'D' as soon as fuel free from air issues from the vent.

If, however, a new pump has been fitted to the system, then its governor housing will most likely be empty of fuel oil and venting proceeds as follows.

Leave the governor vent screw 'D' slackened. Next slacken any two injector pipe line connections at the injector end. Set the throttle to the fully open position and turn the engine until fuel free from air flows from the unions. Then retighten the loosened injector pipe unions.

Start the engine and run it at fast idling speed until air-free fuel exudes from the governor vent screw 'D'. Tighten this screw and stop the engine.

Governing may be erratic during this procedure, therefore stand by to stop the engine should any excessive engine speed develop.

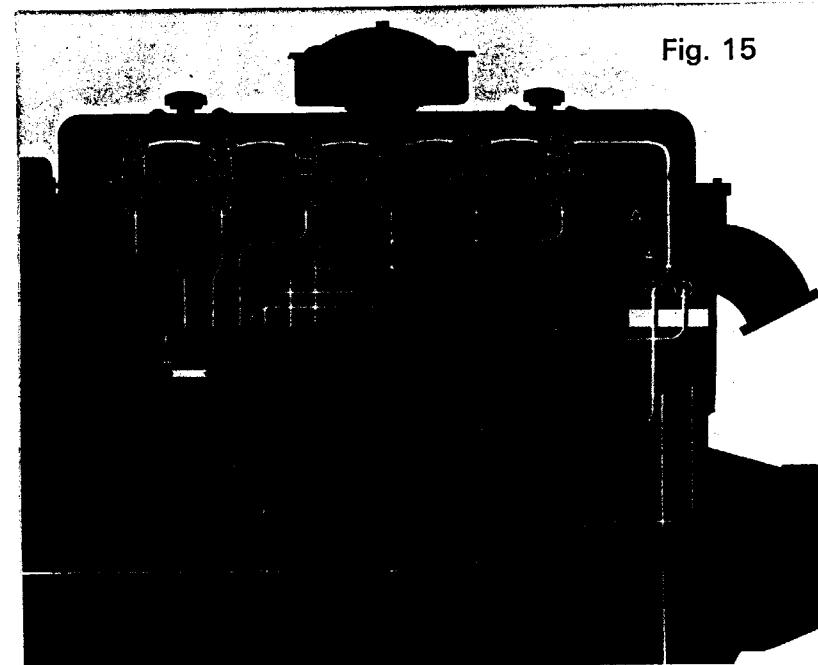

Fig. 15

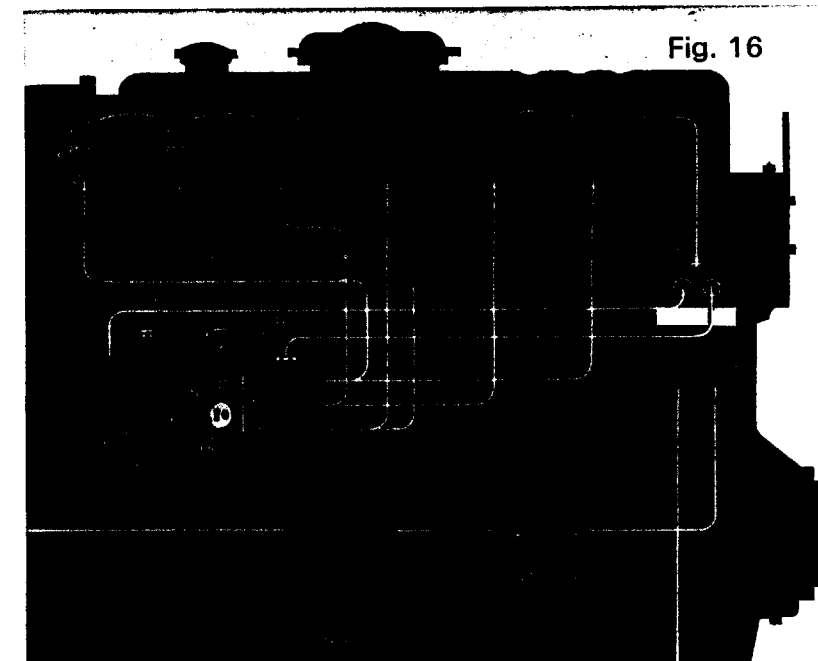
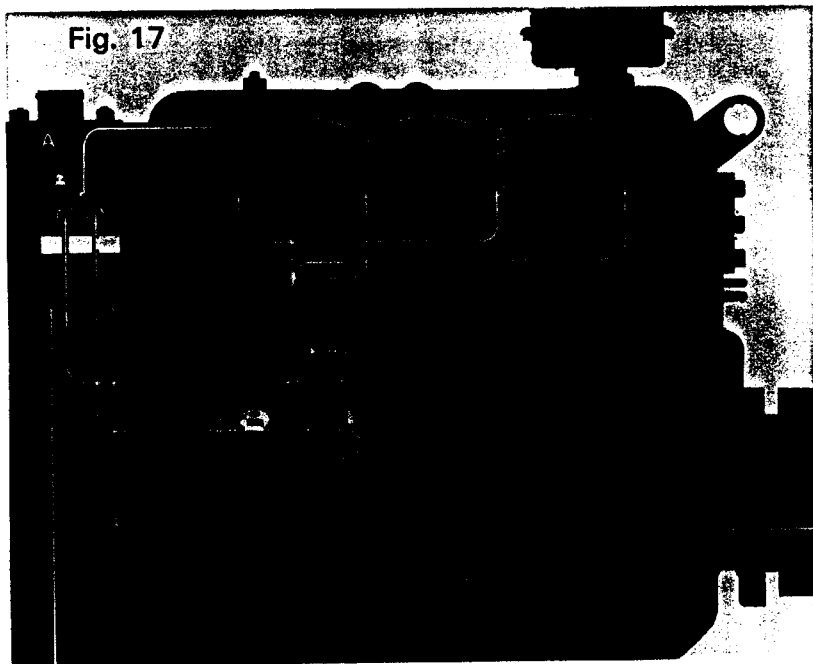

Fig. 16



RECOMMENDED SPARES

Owners are often in doubt as to the amount of fuel injection equipment spares to carry. A great deal depends upon the use of the craft and its location. General coastal use in well-populated areas is one thing, but voyaging up the Amazon delta, for example, would be quite different and would require a comprehensive spares kit.

Generally speaking, the average boat owner is within relatively easy reach of service centres and requires spares only as insurance against breakdown and for general servicing within the scope of the owner or crew.

A suitable kit for such a purpose would consist of a replacement filter element and a set of sealing and 'O' rings for each filter. Spare vent screws for pumps and filters are also required, for screws are easily lost or damaged in a boat when venting the system. A full set of high pressure injection pipes should also be carried, for a fractured or cracked pipe could occur at any time and no patching is possible with these pipes. The correct set of pipes can be obtained from the engine manufacturer's agent or service centre and will be supplied already bent to shape and cleaned internally with both ends plugged against the entry of dirt. They will be supplied packed as a set and it is important to keep them this way until required for use. It is vitally important that the internal surface of the pipe is kept scrupulously clean until fitted to the engine.

A spare set of fuel injectors of the right type and correctly set for the particular engine together with a set of the correct seating washers will not only enable defective injectors to be changed when required but will also permit engine use while one set is away being serviced. Do be careful to check with the engine manufacturer's handbook regarding whether the engine requires injector seating washers or not.

Additionally, spare banjo bolts and washers for back leak pipes and low pressure pipes are handy things to have when a joint starts leaking. Remember no equipment ever breaks down when it is stationary in port. Breakdowns and trouble occur when the equipment is working—and that means at sea!

Do not forget the tools. Always carry the correct spanners for the job—hammers and adjustable wrenches may be all right in some locations, but please, not around your fuel injection equipment on your craft.

HINTS AND TIPS

The theme of this booklet has been to stress the need for absolute cleanliness of the fuel at all times. This requirement also extends to methods of operating and servicing the equipment and to precautions about refuelling.

A useful hint when changing filter elements is to obtain a polythene bag large enough and strong enough to hold the filter element and put this around the element and filter head *before* unscrewing the centre bolt. Undo the centre bolt and allow element, oil and base all to go into the bag. Then empty the bag into a bowl or container large enough for the contents to be separated and the base and sealing rings recovered if required.

Granulated pieces of a substance familiar to all cat owners who live in flats etc and sold for use in cat litter boxes is ideal for soaking up diesel fuel spilt when venting or removing pipe lines. Put the material down *before* working on the system.

Barrier creams of the oil-defying kind are useful and make life much easier when removing the grime from hands. Put on the cream before the job is tackled and then dirt, grease and cream are removed together when the job is completed.

In the majority of fuelling installations fuel will be supplied through a hose—always wipe the pump nozzle with a clean non-fluffy piece of cloth before use. None of those grubby old swabs, *please*—they will do far more harm than good. If you spill any fuel on tank, deck or fittings, wipe it off right away. Diesel fuel oil does not evaporate as does petrol, and if left, will gather dirt and grit, will track everywhere and keep on smelling. Be careful where you put down the fuel tank cap when refuelling—see that it doesn't pick up dirt or grit—this is how quite a lot of dirt gets into the tank.

Avoid dubious sources of fuel. Job lots of unknown origin are not always the bargain they appear to be and fuel injection equipment is expensive to renew when damaged.

INCORRECT IDLING AND MAX SPEED

LOSS OF POWER—POOR CONSUMPTION

UNEVEN RUNNING—MISFIRING

EXCESSIVE EXHAUST

DIFFICULT STARTING

CAV

FUEL INJECTION EQUIPMENT

FAULT DIAGNOSIS

SYM	TO	CAUSE	CHECK
		1 No fuel	1 Fuel level
		2 Stop control	2 In run position and linkage free
		3 Starting procedure	3 Is it correct
4	4	4 Air in system	4 That system is vented and all joints and unions air tight
5	5	5 Fuel restriction	5 Filters and pipes clear
		6 Fuel contamination	6 That fuel is free of water, dirt, ice and wax
		7 Cranking speed	7 Correct Lub. oil. Battery, starter and cable connections
		8 Starting aid	8 Correct functioning. Fuel supply and electrical connections
	9	9 Injection timing	9 Pump to engine timing
10	10	10 Feed pump	10 Pressure
11	11	11 Blocked return pipe	11 DPA back leak, return to tank and filter vents are free
12	12	12 Poor compression	12 Cyl. comp. Air intake clear. Injector seats. Valve clearances & timing
13	13	13 Exhaust system	13 Unrestricted
14	14	14 Fuel atomisation	14 Injectors— type, setting, condition, sealing and evenly tightened down
15	15	15 Fuel tank vent	15 Vent unrestricted
16	16	16 Firing order	16 HP pipes fitted in correct order
	17	17 HP pipe restriction	17 HP pipe bores not kinked or reduced at nipples
18	18	18 HP leaks	18 HP pipe joint tightness
19	19	19 LP leaks	19 Fuel pipes for leaks
20	20	20 Idling speed incorrect	20 Engine idling speed setting
21	21	21 Max speed incorrect	21 Engine maximum no load setting
22	22	22 Accelerator linkage	22 Lever loose on pump, reaches stops. Linkage wear. Pedal stop setting
	23	23 Engine mounting	23 Mountings are tight
	24	24 Vibration	24 Vibration not transmitted from elsewhere
	25	25 F I pump mounting	25 F I pump drive and mounting bolts tight
26	26	26 F I pump	26 If all else fails remove F I pump and send for specialist check