 **NAUTA[®]**



**Flexible Tanks
For Water, Fuel
and Waste**

Nauta Flexible Tanks

Nauta Flexible Tanks provide many advantages over rigid tanks and have, therefore, become very popular with both yacht-builders and boat-owners.

Each of these tanks uses an extremely rugged 840-denier nylon fabric, coated on both sides with a neoprene/nitrile compound. Heavily lapped seams are inside-reinforced with a "doubler" to provide extra strength.

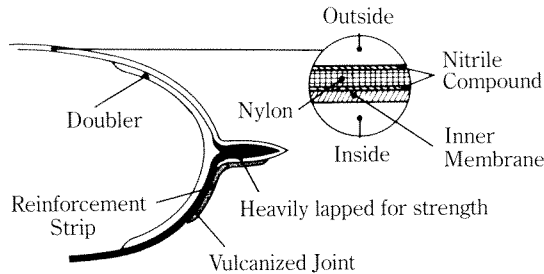

All Nauta tanks are vulcanized to assure leakproof panels and seams for years of trouble-free service. And all are covered by warranty.

Because of their flexibility and the Nauta range of sizes, these tanks can fit into almost any space, especially those odd-shaped places that would otherwise be wasted.

Nauta Tanks are very easy to work with. Several for water and holding are available with fittings already installed. But Nauta's construction allows custom placement of fittings to suit your particular requirements and makes it simple to install them. The low cost of tanks and installation appeals to everyone.

A flexible tank is unique in operation: as liquid is drawn out, the tank "collapses." This not only eliminates the need for venting of water tanks but also minimizes free-surfacing action (turbulence in the airspace above liquid) which dramatically reduces sloshing and its noise.

	Maximum Capacity U.S. Gallons	Dimensions(Inches) When Empty	Reference Number
Water	14½	26½ x 24½	FT-911-120
Neoprene/Nitrile	23½	26½ x 33½	FT-911-150
With Tedlar™ Liner	35½	26½ x 45½	FT-911-160
	53	26½ x 62½	FT-911-180
Water*			
Same as Above but With Fittings Already Installed	14½	26½ x 24½	FT-911-122
	23½	26½ x 33½	FT-911-152
Sewage Holding or Small Diesel Fuel:			
Neoprene/Nitrile with Tedlar™ Liner; no tie-downs	14½	27 x 25	FT-915-120
	25	27 x 34	FT-915-150
	37	27 x 46	FT-915-160
Sewage Holding*			
Neoprene/Nitrile with Tedlar™ Liner; Fittings Installed	14½	27 x 25	FT-915-122
	25	27 x 34	FT-915-152
Large Diesel Fuel*:			
Neoprene/Nitrile	53	27 x 63	FT-915-680
Fittings Installed	80	55 x 50	FT-945-621
	125	55 x 60	FT-945-622
	200	55 x 80	FT-945-624
Extra-Large Diesel Fuel*:			
Neoprene/Nitrile Fittings Installed	300	55 x 110	FT-945-626
	400	55 x 143	FT-945-628
Portable Outboard Fuel Tanks			
	6	16½ x 10 x 9	FB-521-100
	9	16½ x 10 x 12½	FB-521-101
	18	16½ x 10 x 24	FB-521-103

Dimensions (except on Outboard Tanks) are for empty tanks; when tanks are mounted horizontally and filled, these dimensions reduce by 10%–15%. The filled depth (highest to lowest point) ranges from 30 to 40 cms (12"–16"), depending upon tank size. Stated capacities are given for optimum expanding conditions (a flexible tank conforms to and is limited by the space in which it is mounted).

	Water	Holding	Large Diesel	Extra-Large Diesel
*Tanks which are marked with an asterisk above are supplied with the following fittings installed (see back page for description of fittings):				
Fill	#1210	#2221	#3254	#3254
Draw	#1300	#2221	#2254	#2254
Vent	n.a.	#300E	n.a.	n.a.
Straps	n.a.	n.a.	Two (2)	Four (4)

Water holding diesel

Our most popular application is also the easiest way to increase or replace water capacity on boats whose tankage is inadequate or deteriorated.

Nauta Flexible Water Tanks use an exclusive Tedlar™ inside lining to maintain a taste-free system: most PVC, fiberglass, other plastics and metals contribute a distinct, unpleasant flavor to fresh water; Tedlar doesn't. No venting is required for water tanks, only a fill pipe and a simple draw line to head and/or galley pumps. 5-year warranty coverage.

These tanks are also popular among some sailors who use them as ballast tanks, knowing that the contents can also be used for emergency drinking water.

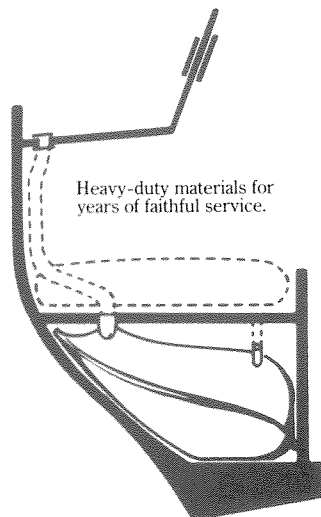

Heavy-duty materials for years of faithful service.

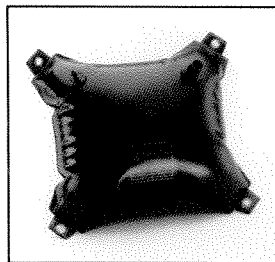

Nauta's heavily lapped, doubled and vulcanized seams simply cannot leak.

The more rigorously enforced laws against overboard discharge now make non-compliance extremely costly. A Nauta Flexible Holding Tank, on the other hand, provides a relatively inexpensive Type III solution. In addition, the Tedlar™ lining of these Nauta tanks prevents gas permeation, thus stopping a major odor problem with many other holding tanks.

Combined with a few other components, this solution is both legal and far less costly than replumbing a vessel or installing a more complex and expensive Type I or Type II system: it occupies less space and requires no electrical power. The illustrated example would allow those traveling into unrestricted waters to pump overboard. 1-year warranty coverage.

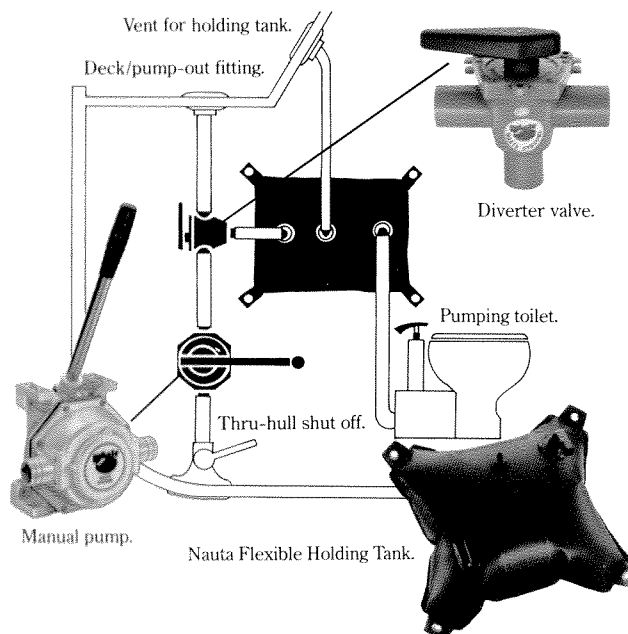

Nauta Flexible Holding Tank.

Nauta Flexible Diesel Tanks can dramatically extend the range of diesel-powered sail and motor yachts. They can deck or cockpit mount to gravity feed (or be hand-pumped to) tankage belowdecks. And, when empty, these flexible tanks can be rolled up and stowed!

Sport and commercial fishermen heading into offshore waters and cruisers visiting remote ports (where refueling may be unavailable or of suspect quality) will find these Nauta Tanks an ideal, low-cost solution.

Nauta diesel tanks of 53 gallon capacity and larger are supplied with adjustable hold-down straps with D-rings. Two N.P.T. brass fittings ($3/4$ " and $1\frac{1}{2}$ ") allow this system to connect with conventional fuel-line piping. 1-year warranty coverage.

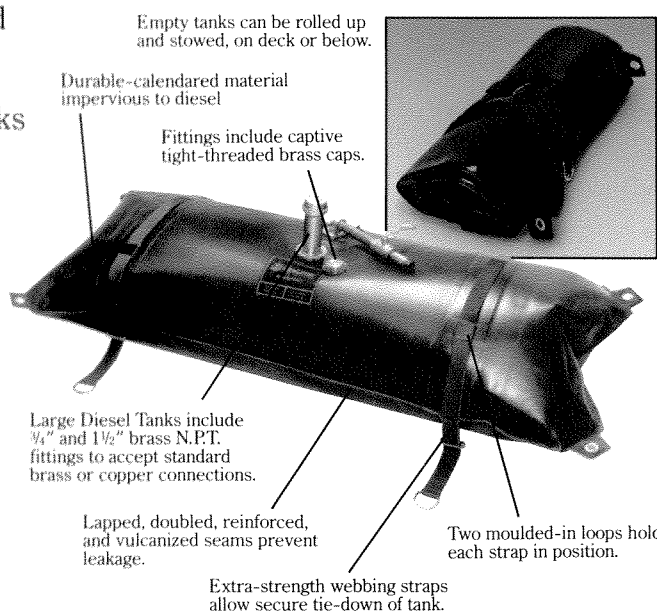

Empty tanks can be rolled up and stowed, on deck or below.

Durable-calendared material impervious to diesel

Fittings include captive tight-threaded brass caps.

Large Diesel Tanks include $3/4$ " and $1\frac{1}{2}$ " brass N.P.T. fittings to accept standard brass or copper connections.

Lapped, doubled, reinforced, and vulcanized seams prevent leakage.

Extra-strength webbing straps allow secure tie-down of tank.

Two moulded-in loops hold each strap in position.

outboard fittings installation & maintenance

Nauta Flexible Outboard Tanks are a remarkable improvement over the traditional painted metal tanks. Perhaps the most noticeable change: they don't leave rust rings on the floorboards or cockpit sole.

These roll-up-when-empty tanks offer convenience in use and in stowage. They are also more comfortable to carry than most rigid tanks. They cannot rust, won't scrape your paint, are easier to tie down and don't rattle when you're underway.

Available in 6, 9 and 18 gallon capacities, they show by their size how much fuel remains inside. While slightly more expensive than metal, Nauta Flexible Outboard motor fuel tanks are a far better long-term solution.

Pivoting fill spout stows in securing-sleeve. Tight-fitting screw-cap.

Capped and vented fuel draw.

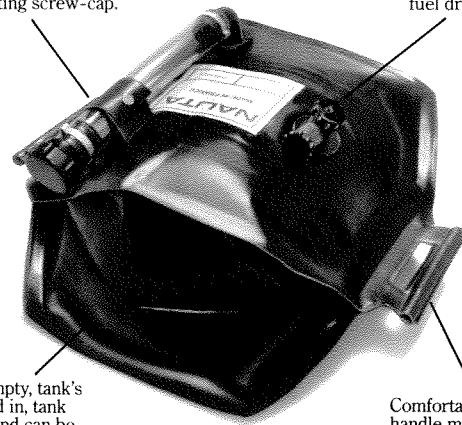

When empty, tank's sides fold in, tank flattens and can be rolled up.

Comfortable carrying handle makes secure tie-down connection.

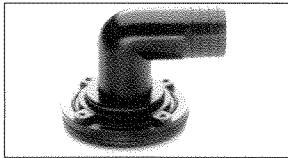

FTP-2221
90° Straight Fill—1½"

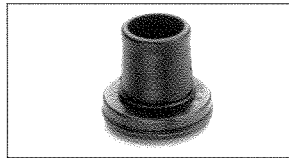

FTP-1210
Straight Fill—1½"

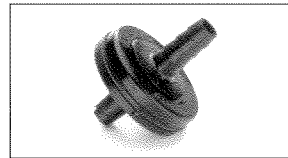

FTP-1300
Straight Drawing Nipple—1½"

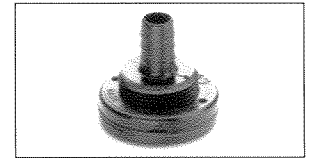

FTP-300E
Vent (Fuel or Holding)—5/8"

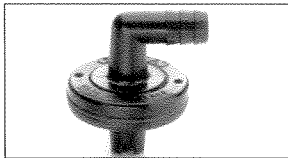

FTP-311
90° Drawing Nipple—5/8"

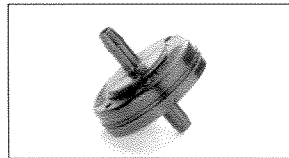

FTP-400
Straight Drawing Nipple—1/4"

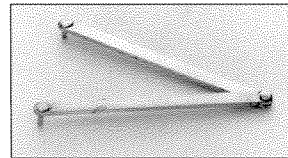

FTP-010
Spanner Wrench

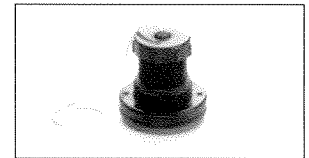

FTP-215
Straight Fill with Cap—1"

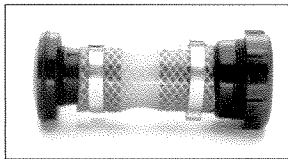

FTP-720
Extended Straight Fill with Cap—1½"

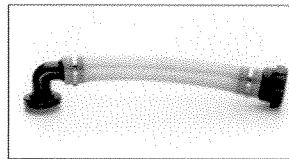

FTP-700
90° Extended Straight Fill with Cap—1½"

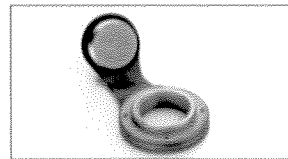

FTP-3254
N.P.T. Brass Fitting with Cap—1½"

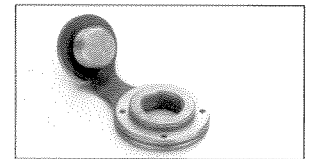

FTP-2254
N.P.T. Brass Fitting with Cap—3/4"

Ordering Information When ordering a Nauta Flexible Tank, you must specify whether that tank will be used for water, holding or diesel fuel. Tanks, except those specifically noted, are NOT supplied with fittings. If the tank you want isn't supplied with fittings, we recommend the following fittings for those applications listed:

Each Nauta Tank is supplied with a card providing easy-to-follow installation and maintenance instructions.

For installation, tanks should be positioned in a shaped bed in a space free of protrusions. Fittings which need to be installed can be positioned and mounted in just minutes using scissors and a Nauta wrench (#FTP-010); always mount fittings on the top of tanks to prevent wear on the tanks.

Flexible tanks are easier to maintain than

	Water	Holding	Diesel
Fill	#1210	#2221	Consult your dealer or a distributor for recommendation.
Vent	—	#300E	
Draw	#1300	#2221	

rigid tanks because they can be removed for cleaning, inspection or repair without structural work. They will not corrode and are impervious to saltwater and other liquids they might encounter belowdecks.

Periodic maintenance recommendations for water tanks offer common-sense steps that should be followed for any water tankage to prevent the buildup of micro-organisms which degrade the taste and can affect potability.

CAUTION: All fuel tanks, except those specifically built for outboard motor fuel, are for diesel fuel only. Outboard tanks are for external use only and must not be installed below decks. The following warnings apply to all fuel tanks: a) keep away from any ignition source; b) secure in a well ventilated location; c) do not allow internal or external pressure to build up; and d) do not fill tanks where spillage can run into the bilge.



IMTRA CORPORATION
30 Barnet Boulevard
New Bedford, MA 02745
Phone: 508-995-7000
Fax: 508-998-5359