



SIMRAD
A KONGSBERG Company

MAXIMISING YOUR PERFORMANCE AT SEA

M A N U A L

Simrad TP22 & TP32

Tillerpilots

© 2004 Simrad Ltd

The technical data, information and illustrations contained in this publication were to the best of our knowledge correct at the time of going to print. We reserve the right to change specifications, equipment, installation and maintenance instructions without notice as part of our policy of continuous development and improvement.

No part of this publication may be reproduced, stored in a retrieval system or transmitted in any form, electronic or otherwise without prior permission from Simrad Ltd.

No liability can be accepted for any inaccuracies or omissions in the publication, although every care has been taken to make it as complete and accurate as possible.

CONTENTS

1 GENERAL

1.1 Introduction	6
1.2 SimNet network system	7

2 OPERATION

2.1 General	8
2.2 Autopilot mode	8
2.3 Adjusting course	9
2.4 Autotack	10
2.4.1 Autotacking in Compass mode	10
2.4.2 Autotacking in Wind mode	10
2.4.3 Autotacking in Nav mode	11

3 ADVANCED FEATURES

3.1 Nav mode	12
3.2 Steer To Wind	13
3.3 Using an external compass	14

4 CONFIGURATION

4.1 Porthand mounting	15
4.2 Calibration mode	16
4.3 Adjusting Gain	16
4.4 Adjusting Seastate	17
4.5 Autotrim	18

5 INSTALLATION

5.1 Fitting the Tillerpilot	19
5.2 Electrical installation	21
5.3 Interfacing via SimNet	22
5.4 Interfacing via NMEA	22
5.5 Electronic interference suppression	23
5.6 Auto compass calibration	24
5.7 Configuring the Tillerpilot on the SimNet bus	25

6 APPENDIX

6.1 Advice on operation	27
6.2 Fault finding	28
6.3 NMEA sentences received	29
6.4 Spares & accessories	30
6.5 Dimensions	31
6.6 Specification	31
6.7 Service & Warranty	31

1 GENERAL

1.1 Introduction

The TP22 & TP32 Tillerpilots from Simrad are suitable for a wide variety of tiller-steered sailing yachts up to 12m (39 ft) overall length.

Combining highly sophisticated electronics with advanced software and a powerful mechanical drive, they are capable of providing reliable and accurate steering performance under a variety of different conditions with minimal current consumption.

The Tillerpilots have been designed so that, while they represent the state-of-the-art in marine autopilots with many advanced features, they remain very simple to operate, using only five keys to access all functions.

Sophisticated functions available include Steer To Wind mode and Nav mode (Steer To GPS) using external equipment linked directly to the Tillerpilot via the SimNet high-speed bus or through the inbuilt NMEA0183 interface.

There is also the option to operate the Tillerpilot remotely using the HR22 Hand Remote. For more details, refer to the separate instruction card supplied with the HR22.

To ensure the best results from your Tillerpilot it is essential that the unit is installed correctly. Please read this manual thoroughly before installation.

Thank you for choosing Simrad.

If you are pleased with your Tillerpilot, we hope you will be interested in our range of marine electronic equipment, which is manufactured to the same high standards as the Tillerpilot. Please contact your nearest Simrad Agent for a catalogue showing our increasing range of high-tech navigational instruments, GPS, Chartplotters, Autopilots, Radars, Fishfinders and VHF radio sets.

Simrad operate a policy of continual development and reserve the right to alter and improve the specification of their products without notice.

Tillerpilot® is a registered trademark of Simrad Ltd.



*Fig 1.1 - Tillerpilots
TP22 & TP32*

1.2 SimNet network system

The SimNet system is built around a high-speed bus networking system, that allows Simrad instruments, navigation equipment and autopilots to be easily interconnected and share data.

All units are interconnected and powered using a standard single cable (Fig 1.2) -

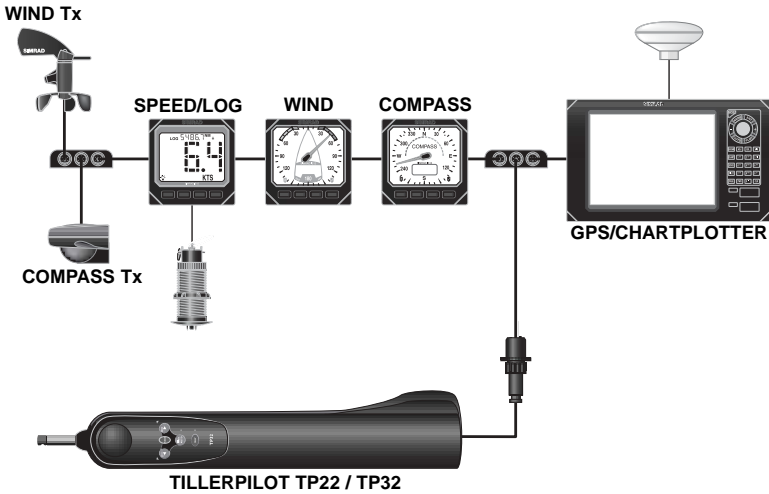

Fig 1.2 - Typical SimNet system

The Tillerpilot can receive navigational information from the Chartplotter for Steer To GPS (Nav mode).

It will also accept wind angle data from the wind transducer for Steer To Wind mode, boat speed data from the speed instrument and heading data from the compass transducer.

Additionally, heading data from the Tillerpilot can be displayed on any instrument displays capable of showing compass information.

NOTE

Heading data from the Tillerpilot will only be shown on instrument displays, if there is no compass transducer present on the network (priority is always given to SimNet compass transducers for heading data).

2 OPERATION

2.1 General

The keypad of the Tillerpilot has been designed to be as simple and intuitive to operate as possible. Using only five keys (Fig 2.1), it is possible to perform precise course adjustments and navigational functions -

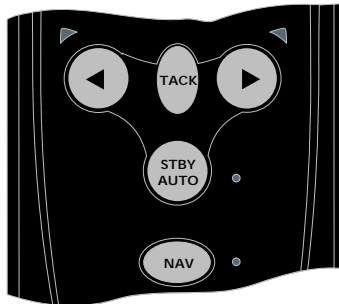

Fig 2.1 - Tillerpilot keypad

The unit powers up in Standby mode, indicated by a flashing LED next to the **STBY/AUTO** key (Fig 2.2) -

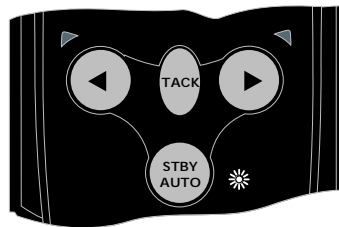

Fig 2.2 - Standby mode

The two direction LEDs above the **Port** (◀) and **Starboard** (▶) keys are always dimly lit, which provides night illumination for the keypad. All functions are confirmed audibly by a “beep” and visually by the LEDs, so the status of the unit can always be confirmed at a glance.

2.2 Autopilot mode

While in Standby mode, the pushrod can be manually driven in and out by pressing the arrowed Port and Starboard keys, which allows “power steering” of the vessel.

To engage Autopilot mode, press the **STBY/AUTO** key, and the Tillerpilot will lock onto the current course. The LED next to this key will stop flashing and remain permanently lit as long

as the pilot is in Autopilot mode (Fig 2.3) -

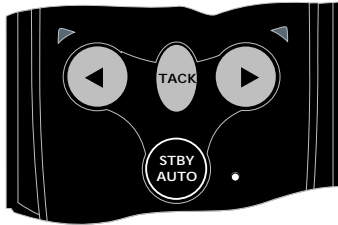

Fig 2.3 - Engaging Autopilot mode

To lock the pilot onto the desired course, either steer the correct course and then engage the autopilot, or engage the autopilot and then adjust the heading until the correct course is being sailed (see section 2.3 below). If the **STBY/AUTO** key is pressed and held, the pilot will beep a second time and lock onto the previously used heading (this feature will not be available if the unit has just been switched on).

2.3 Adjusting course

In Autopilot mode, precise course adjustments can be easily made - press the **Port** (◀) or **Starboard** (▶) key once and a 1° course adjustment will be made in the specified direction. This is confirmed by a single beep and the Port or Starboard LED will flash once. Press and hold the key and a 10° course adjustment will be made, confirmed by a double beep and a double flash of the Port or Starboard LED (Fig 2.4) -

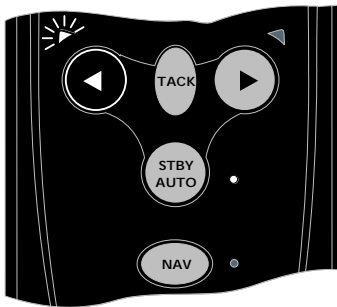

Fig 2.4 - Course adjustment to Port

NOTE

Following any course adjustment in Nav mode (see section 3.1), the Tillerpilot will gradually return to the navigation track.

2.4 Autotack

The Tillerpilot has a built-in autotack facility, allowing easy tacking of the vessel when single or short handed. An autotack is only possible when in Autopilot mode.

To initiate autotack, press and hold the **TACK** key, followed by either the **Port** (◀) or **Starboard** (▶) key, depending on which direction you wish to tack (Fig 2.5) -

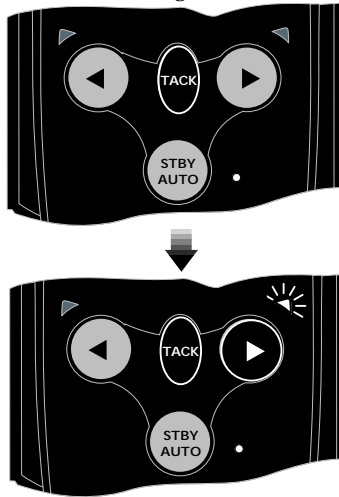

Fig 2.5 - Initiating Starboard autotack

The operation of the Tillerpilot will differ during an autotack depending on whether the pilot is in Sail To Compass or Steer To Wind mode:

2.4.1 Autotacking in Compass mode

If in Compass mode (default), the Tillerpilot will tack the vessel in the selected direction. The Tillerpilot has a factory preset autotack angle of 100°.

2.4.2 Autotacking in Wind mode

The Tillerpilot will tack the vessel through to the same apparent wind angle, but on the opposite tack.

NOTE As a safety feature, the Tillerpilot will only allow an autotack if the apparent wind is less than 90° – i.e. autotack is disabled when sailing downwind.

NOTE In this mode, the Tillerpilot automatically prevents tacking in the wrong direction – if on Port tack, only an autotack onto Starboard tack will be possible.

In all cases, the autotack is confirmed by a long beep, with the relevant Port or Starboard LED flashing during the course change.

2.4.3 Autotacking in Nav mode

As the Tillerpilot will be steering directly to a waypoint, the autotack facility is disabled while in Nav mode.

If it is necessary to perform an autotack, disengage Nav mode by pressing the **NAV** key then perform the autotack.

WARNING

Ensure that the boat is on the correct tack before re-engaging Nav mode.

3 ADVANCED FEATURES

The TP22 and TP32 Tillerpilots contain many advanced features, one of which is the ability to accept course data from a variety of sources apart from the internal fluxgate compass, including SimNet- and NMEA-compatible navigational receivers (GPS/chartplotters, etc) and windvanes. An external SimNet compass can also be used.

3.1 Nav mode

The Tillerpilot can interface directly with compatible Simrad Chartplotters via the SimNet high-speed data bus. It also has an inbuilt NMEA interface, which allows connection to NMEA0183-compatible GPS and chartplotters.

Once interfaced with a GPS or chartplotter, the Tillerpilot can steer using data from this source in addition to the internal compass, allowing it to steer to a waypoint with great accuracy.

To activate Nav mode, the unit must be in Auto mode (press **STBY/AUTO**). Simply activate a waypoint or route programmed into the GPS/chartplotter, and press the **NAV** key. The LED next to the **NAV** key will light and the Tillerpilot will steer to the first waypoint, using Cross Track Error and Bearing To Waypoint information from the navigational receiver to maintain an accurate course (Fig 3.1) -



Fig 3.1 - Activating Nav mode

On arrival at the target waypoint an intermittent alarm will sound. As a safety feature, to avoid an unexpected course change, the next waypoint will not be automatically loaded until the **NAV** key is pressed. When the vessel reaches the final waypoint, the Tillerpilot will continue its current course under Compass (Auto) mode.

NOTE

Some of the standard key stroke functions may have a different effect in Nav mode than in Compass mode. Please refer to sections 2.3 and 2.4.3.

3.2 Steer To Wind

The Tillerpilot can sail to the apparent wind angle rather than a compass course, using wind data via the SimNet or NMEA interfaces. Due to the faster data rate, the use of a SimNet windvane such as the Simrad IS12 Wind is recommended – priority will be given to SimNet wind data over NMEA wind data received by the Tillerpilot.

NOTE

If no wind information is present, the Tillerpilot will not enter Steer To Wind mode.

To select Steer To Wind mode, the unit must be in Auto mode (press **STBY/AUTO**).

Press and hold the **Port** (◀) and **Starboard** (▶) keys together until a double beep is heard (Fig 3.2) -

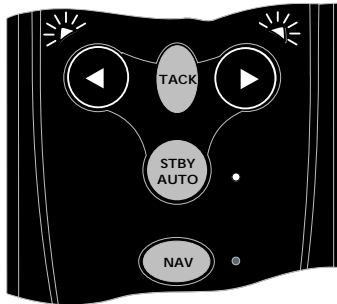

Fig 3.2 - Selecting Steer To Wind mode

Both the Port and Starboard LEDs will flash simultaneously while the pilot is in Steer To Wind mode.

To switch back to Compass mode, simply press and hold the ◀ and ▶ keys together again until a double beep is heard.

While in Steer To Wind mode, the Tillerpilot will lock onto the current apparent wind angle being sailed. Any course adjustments made will be relative to the apparent wind angle, rather than the compass heading as when in Compass (Auto) mode.

Initiating an autotack will turn the boat onto the same apparent wind angle on the opposite tack. As a safety feature, autotack is disabled when sailing downwind.

NOTE

Nav mode cannot be selected while in Steer To Wind mode – to activate, return to Compass (Auto) mode first.

3.3 Using an external compass

Normally, the accurate operation of a self-contained autopilot is very difficult on a ferrous hulled boat (steel, ferro cement, etc). as the hull will affect the bearing read by the internal flux-gate compass.

Although the Tillerpilot operates using its inbuilt fluxgate compass, it will give priority to an external SimNet Compass, if detected on the network bus.

On a steel or ferro hulled boat, the correct location for the external compass would be on the mast, between 1 and 2 metres above the deck (Fig 3.3). On a non-ferrous hulled boat, the compass should be situated low down, as near the centre point of the boat as possible, but away from any sources of magnetic interference such as speakers, etc.

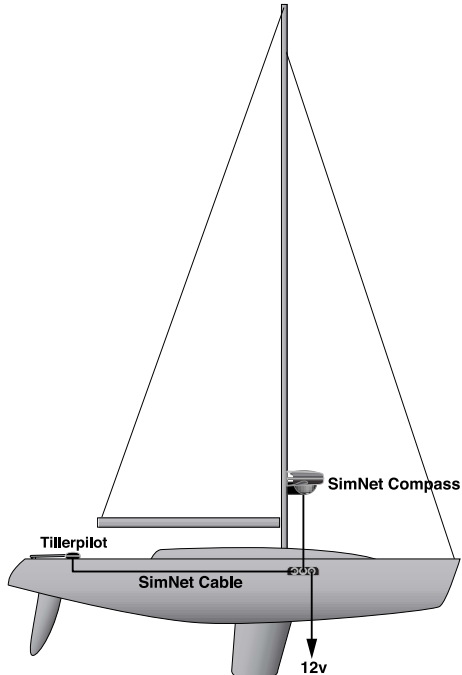

Fig 3.3 - Using Tillerpilot with an external compass

4 CONFIGURATION

4.1 Porthand mounting

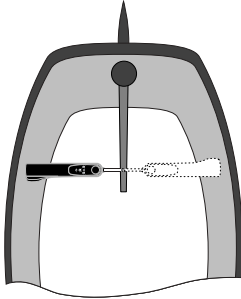

Fig 4.1 - Starboard and Port mounting options

Although the Tillerpilot is factory preset for Starboard-side mounting, it is possible to reconfigure it for mounting on the Port-side of the cockpit, to facilitate easy installation on most types of yacht.

With the power off, hold down the NAV and TACK keys and switch on the power. The Port or Starboard LED will illuminate, depending on the current mounting configuration. Press the **Port** (◀) key to select Port-side mounting – the Port LED will illuminate to indicate selection. Confirm selection and exit to Standby mode by pressing NAV (Fig 4.2) -

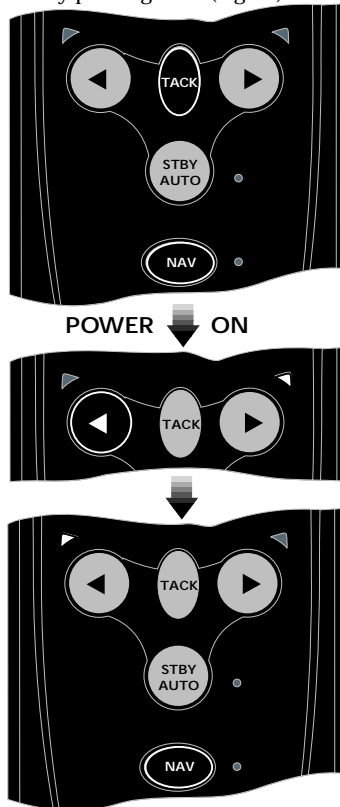

Fig 4.2 - Configuring for Porthand mounting

To select Starboard mounting, repeat the above procedure, but press the **Starboard** (▶) key.

4.2 Calibration mode

The Gain and Seastate settings can be adjusted while the Tillerpilot is in either Standby or Autopilot mode.

Press and hold the **TACK** key, then press **NAV** (Fig 4.3) -

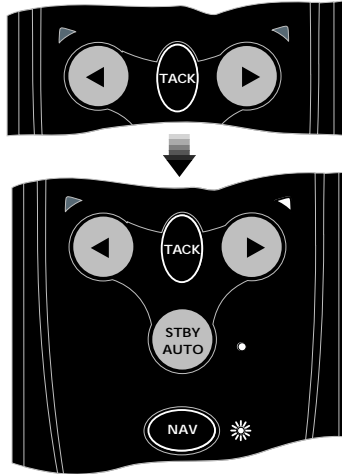

Fig 4.3 - Entering Calibration mode

The Starboard LED will illuminate to indicate that Gain adjustment is selected. To toggle between Gain and Seastate adjustment, press **TACK** - the Port LED will illuminate for Seastate.

4.3 Adjusting Gain

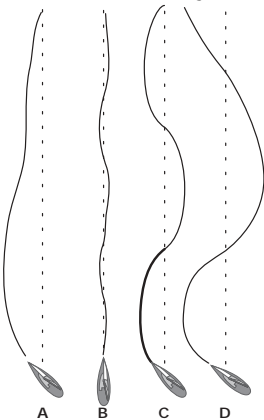

Fig 4.4 - Effects of Gain setting

The Tillerpilot will apply adjustments to the tiller, in order to compensate for heading variations, the amount of movement being proportional to the heading error detected by the compass unit. The amount of movement is set by the Gain (sometimes referred to as the rudder ratio).

The Gain setting can be likened to driving a motor vehicle – at high speeds, very little wheel movement is necessary to steer the vehicle (LOW gain). When driving at slow speeds, more wheel movement is necessary (HIGH gain).

Fig 4.4 shows the effect of setting the Gain too low (**A**) - the vessel takes a long time to return to the correct heading. **B** shows the ideal setting, where errors are quickly corrected. **C** illustrates the effects of setting the Gain too high, which causes the vessel to oscillate around the correct heading. Excessive Gain (**D**) creates a tendency to instability of course, leading to increasing error.

When Gain is selected, the Nav LED will flash and a repeated sequence of beeps will be heard. The number of flashes and beeps in the sequence indicates the level of the Gain setting.

Use the **Port** (◀) and **Starboard** (▶) keys to adjust the Gain setting between 1 and 9 (Fig 4.5) -

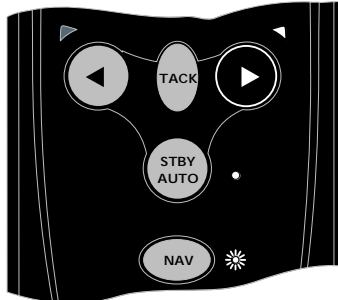

Fig 4.5 - Increasing Gain level

Press **NAV** to confirm settings and return to normal operation, or press **TACK** to switch to Seastate adjustment.

4.4 Adjusting Seastate

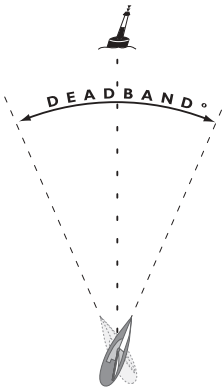

Fig 4.6 - Seastate deadband

In heavy seas, more variations in heading will be detected, and if the Tillerpilot tried to respond to all of these errors, it would be overworked, causing unnecessary strain to the unit and excessive drain on the batteries. Instead, it continuously monitors the corrections applied over the course of a voyage and allows a “dead band” within which the boat can go off course without constant corrections being made (Fig 4.6). The size of the dead band is normally automatically adjusted by the Tillerpilot to give the best compromise between course holding and battery consumption, but it can be set manually if desired:

- In Calibration mode, press **TACK** to toggle between Gain and Seastate adjustment (indicated by the Port LED illuminated). The Seastate level is indicated by the number of audible beeps and flashes of the Nav LED. No beeps or flashes of the Nav LED indicates that the Tillerpilot is set to Auto Seastate.
- Use the **Port** (◀) and **Starboard** (▶) keys to adjust the Seastate setting between 0 and 9. Selecting 0 will switch the Tillerpilot to Auto Seastate.
- Press **NAV** to confirm settings and return to normal operation.

4.5 Autotrim

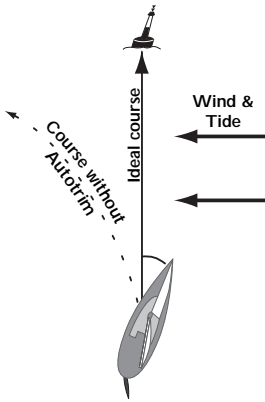

Fig 4.7 - Effects of autotrim

Under differing conditions a tiller bias (sometimes known as standing helm or rudder trim) is applied in order to steer a straight course. An example is when sailing close hauled, where the vessel will normally pull into the wind, and the helmsman applies a standing helm to leeward, in order to maintain course. The amount of this standing helm varies according to factors such as strength of wind, boat speed, sail trim and amount of sail set. If no account of these were taken, then the vessel would tend to veer off course, or pull around head-to-wind when sailing close hauled.

The Tillerpilot continuously monitors the average course error and applies a bias to the tiller to compensate, until the optimum condition is reached (Fig 4.7). This bias, or standing helm, is applied gradually, so as not to upset the normal performance of the Tillerpilot. Thus, it may take up to a minute or so to fully compensate after changing tack. Once optimum trim is reached, the pilot will still monitor for changes in the prevailing conditions and update the trim accordingly.

NOTE

Autotrim is applied automatically and cannot be manually adjusted.

5 INSTALLATION

5.1 Fitting the Tillerpilot

The Tillerpilot is a very sophisticated piece of equipment, and therefore, in order for it to function to its full capabilities, it is essential that it is installed correctly. Please read this section thoroughly before attempting installation and use.

The Tillerpilot should be horizontally level when fitted to the tiller (Fig 5.1) -

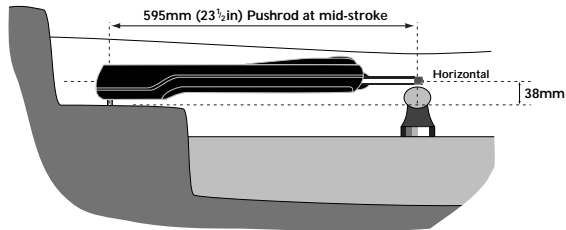

Fig 5.1 - Installation, cross section

With the tiller amidships and the pushrod in the midstroke position, the Tillerpilot should be exactly 90° to the tiller (Fig 5.2) -

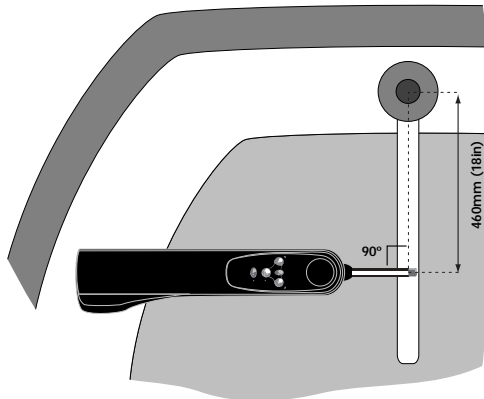

Fig 5.2 - Installation, plan view

NOTE

The pilot is factory preset to be mounted on the Starboard side as shown, but this can be reconfigured for Port-side mounting (see section 4.1).

The dimensions given in Figures 5.1 and 5.2 should be adhered to as closely as possible, especially Fig 5.1. Some tolerance on the distance from tiller stock (Fig 5.2) is permissible, but the Tillerpilot may require a Gain adjustment to compensate.

NOTE If the dimensions given are not practical for the vessel to which the Tillerpilot is to be fitted, a range of fitting accessories are available to facilitate correct installation. Please refer to section 6.4 for more details.

CAUTION The Tillerpilot houses an internal fluxgate compass and should therefore be mounted away from sources of magnetic interference, such as the vessel's steering compass. The minimum safe distance is 1m (3ft 3in).

The Tillerpilot is mounted using a supplied tiller pin and mounting cup, which allows the unit to be fitted and stowed easily.

To fit the tillerpin, drill a 6.3mm (0.25in) hole in the tiller (ensure that this is on the centreline of the tiller and is vertical). Drill to a depth that allows only the top 18.0mm (0.75in) to protrude (Fig 5.3). Fix in place using an epoxy adhesive.

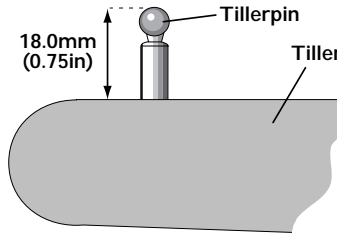

Fig 5.3 - Fitting the tillerpin

To fit the mounting cup, drill a 12.7mm (0.5in) hole into the cockpit seat and mount so that only the flange protrudes. Ensure the cup is a tight fit (use an epoxy adhesive) and is supported over its entire depth – if necessary, reinforce the underside of the cockpit seat with hardwood or marine plywood (Fig 5.4) -

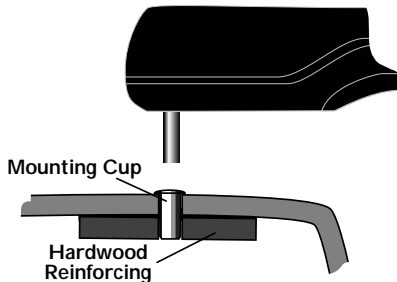

Fig 5.4 - Fitting the mounting cup

NOTE Due to the high loads exerted, do not fit the Tillerpilot to the mounting cup and pin until the adhesive has completely set.

5.2 Electrical installation

The Tillerpilot operates from a 12v DC supply. The waterproof plug fitted to the Tillerpilot is used to supply the power, SimNet and NMEA data.

The bulkhead socket should be mounted in a convenient position close to where the Tillerpilot is to be fitted, and wired as shown (Fig 5.5) -

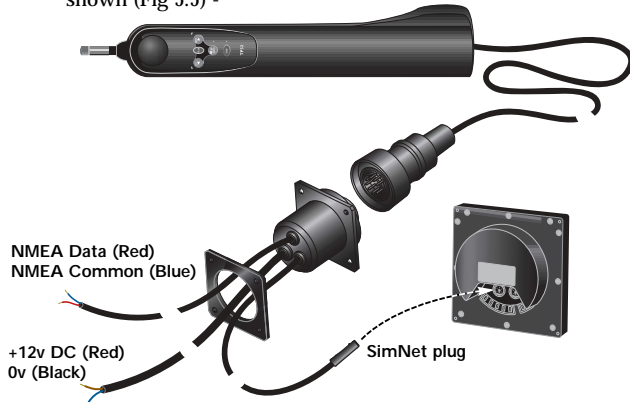

Fig 5.5 - Tillerpilot bulkhead socket wiring

IMPORTANT

If the vessel has more than one separate battery bank, when connecting the Tillerpilot to the power supply, always ensure that the pilot and all interfaced equipment – whether SimNet or NMEA – are connected to the same battery bank, even if they each have independent connections to the switch panel. This is to avoid a possible voltage drop between the interfaced equipment, which would render the equipment inoperative.

Length of cable run	Cross section	Conductor type	AWG
Under 4m (13ft)	1.5mm ²	30/0.25	16
4-8m (27ft)	2.5mm ²	50/0.25	14

Fig 5.6 - Power cable selection table

* Mount the bulkhead socket on a vertical surface to prevent standing water gathering around or in the socket. Always fit the protective cap when the pilot is not plugged in.

* No power is supplied to or from the SimNet bus – the Tillerpilot must always have its own dedicated power connection.

* Use a suitable gauge cable to run from switch panel to the socket (see Fig 5.6).

* Connect to the vessel's switch panel via a 10Amp fuse or breaker.

* Do not fit other electronic or electrical equipment to the supply cable, or "tap into" the supply from a nearby cable – always wire each piece of equipment to its own breaker in the switch panel.

* Ensure all wire ends are tinned, and any connections are well made. Poor contact will result in loss of thrust from the Tillerpilot and slower speed of response.

* If in any doubt, employ a qualified engineer to install the equipment.

5.3 Interfacing via SimNet

The Tillerpilot is linked to other SimNet-compatible equipment via the integral SimNet cable and plug in the bulkhead socket.

All SimNet units (Instruments, Chartplotters, Radars, Auto-pilots, etc) use the same single cable high-speed network bus to share data.

The system is plug-and-play: no setup is required, simply plug the Tillerpilot into the nearest spare SimNet port and it will automatically detect any data on the network that it can use. If there are no spare SimNet ports convenient, a three-way cable joiner can be used to create an additional port (Fig 5.7) -

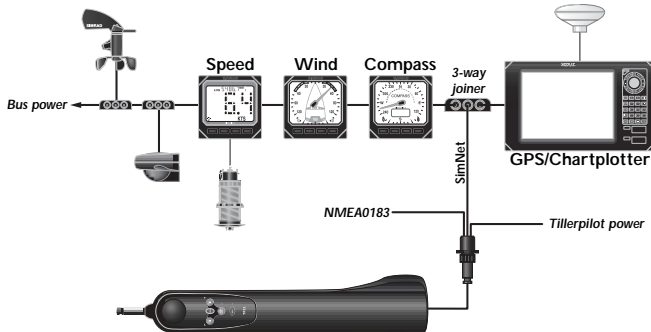

Fig 5.7 - Typical SimNet installation

NOTE

It is not necessary to plug the Tillerpilot directly into any equipment that you wish to share data with – all data is transmitted across the whole bus network.

5.4 Interfacing via NMEA

The inbuilt NMEA processor allows NMEA0183-compatible equipment to be connected directly to the Tillerpilot, without any need for a separate interface unit (Fig 5.8) -

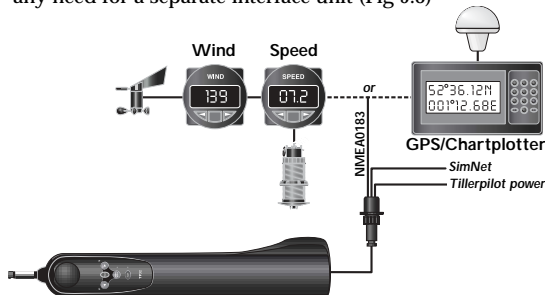

Fig 5.8 - NMEA integration examples

If a GPS or chartplotter is connected to the Tillerpilot, it can extract the data necessary for Nav mode. Other functions such as Steer To Wind may also be available, if NMEA0183-compatible instruments are transmitting the correct NMEA sentences.

When connecting an external (“talker”) unit to the Tillerpilot, two terminals are used – usually labelled DATA and COMMON (or COM). These should be connected to the Tillerpilot’s NMEA cable as follows :

NMEA talker unit	Tillerpilot NMEA
NMEA Out Data/+	Data (Red)
NMEA Out Common/-	Common (Blue)

NOTE

Some third party equipment does not have a dedicated COMMON connection. In this case, the DATA connection will usually be labelled NMEA OUT, and the NMEA Common wire from the Tillerpilot should be connected directly to 0v (terminal 2). If in any doubt, refer to the manufacturer, or Simrad’s Product Support department for advice.

CAUTION

Due to the limitations of NMEA0183, it is recommended that only one talker is transmitting to the Tillerpilot at any one time – i.e. instruments **or** GPS/chartplotter, **not** both simultaneously! If more than one unit needs to be interfaced to the Tillerpilot, these should be connected to the NMEA cable via a changeover switch.

Because of the vast number of different manufacturers and models of navigational equipment, Simrad cannot guarantee correct operation and installation of this equipment. Therefore, before connecting any equipment to the Tillerpilot it is important that the unit’s manual is referred to with regard to interfacing via NMEA.

5.5 Electronic interference suppression

The Tillerpilot has been designed to minimise the effects of interference generated by the engine alternator. However, precautions should still be taken by routing the cables away from the engine compartment. Do not run the cables down trunking carrying high current or radio antenna cables.

Engines with spark ignition, also some refrigerators should be fitted with suppressors. Your local agent should be able to advise on this and supply suppression kits where necessary.

5.6 Auto compass calibration

Once the Tillerpilot is installed, it is necessary to calibrate the internal compass to compensate for deviation caused by any metallic or magnetic objects surrounding it on the vessel.

With the vessel motoring slowly (2–3 knots) in calm conditions and the Tillerpilot in Standby mode, press the **Starboard** (▶) key a number of times to induce a slow clockwise rotation of the vessel. Then press and hold the **TACK** key, followed by the **Port** (◀) and **Starboard** (▶) keys simultaneously (Fig 5.9) -

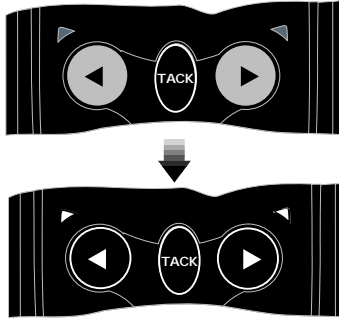

Fig 5.9 - Auto compass calibration

The Port and Starboard LEDs will both light. Allow the vessel to turn through a minimum of 1¼ turns (450°) in approximately 2 minutes, during which time the fluxgate compass will automatically calibrate itself.

If the rate of turn or boat speed is too fast, the Port LED will flash (Fig 5.10). Either slow the boat or reduce the angle of turn.

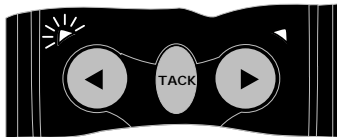

Fig 5.10 - Rate of turn too fast

If the rate of turn or boat speed is too slow, the Starboard LED will flash – either increase the boat speed, or increase the angle of turn. A short beep will indicate that the calibration has been successful, and the Tillerpilot will return to Standby mode. If the calibration has been unsuccessful after a period of four minutes, a long beep will sound.

NOTE

If the calibration routine keeps failing after repeated attempts, this indicates that the Tillerpilot is experiencing excessive magnetic deviation that it cannot compensate for. Check the area within 1m (3ft) of the Tillerpilot for likely sources, such as cockpit speakers or large metallic objects – if these cannot be relocated, it may be necessary to fit an external compass.

5.7 Configuring the Tillerpilot on the SimNet bus

Normally the Tillerpilot can be connected to the SimNet bus and it will automatically detect the nav and instrument data sources, with no user intervention necessary.

If the SimNet bus includes more than one data source, the Tillerpilot will use the first source it detects (Fig 5.11) -

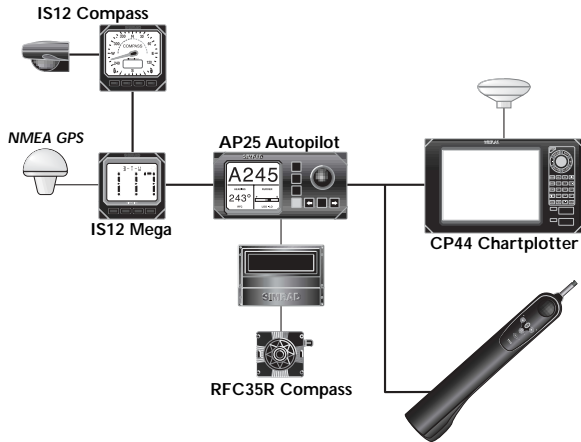

Fig 5.11 - Example of multiple data sources

In the example above, there are two nav data sources (the CP44 Chartplotter and the NMEA GPS via the IS12 Mega instrument) and two external heading sources (the IS12 Compass and the RFC35R Rate Compass via the AP25 Autopilot). The Tillerpilot could be used as a backup pilot, while still using the RFC35R as the heading data source. However, the Tillerpilot may automatically select the IS12 Compass as the heading data source and it may select the Mega instrument as the nav data source instead of the CP44.

If these are not the desired sources, they can be manually configured. Two operation modes are available:

System mode –

This is the default setting – the Tillerpilot automatically selects its own data sources, but it can be reconfigured to use another source by a remote device such as a SimNet Chartplotter or other Command Unit.

Standalone mode –

The Tillerpilot automatically selects its own data source (the first it detects), but cannot be configured by a remote device.

To change the mode, first turn off the Tillerpilot.

To select **StandAlone mode** press and hold the **TACK** and ◀ keys and turn the power on (Fig 5.12) -

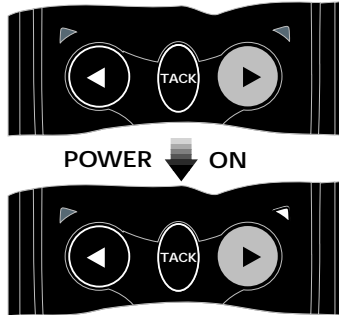

Fig 5.12 - Selecting StandAlone mode

To select **System mode** press and hold the **TACK** and ▶ keys and turn the power on (Fig 5.13) -

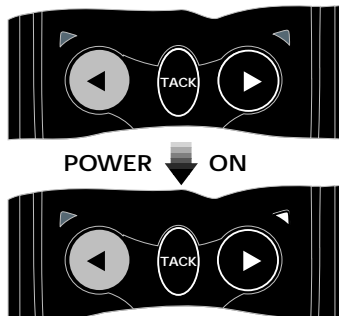

Fig 5.13 - Selecting System mode

The Tillerpilot will beep and all the LEDs will light briefly to confirm the new configuration.

Please refer to the instructions supplied with the relevant Command Unit for details on remote configuring data sources.

NOTE

If there is more than one data source on the SimNet bus, but no Command Unit capable of reconfiguring the Tillerpilot present, the required data source must be the only one present on the bus when StandAlone mode is selected – power down, or disconnect any multiple sources until after the operation mode selection process is complete.

NOTE

Changing the operation mode, or even reselecting the same mode will reset any data source selections that the Tillerpilot was previously locked onto.

6 APPENDIX

6.1 Advice on operation

When used correctly, your Tillerpilot can maintain as good a course, on most points of sail, as a skilled helmsman, with the advantage that it never gets distracted, whereas a human can start showing lapses of concentration after as little as 10 mins.

However, there are certain circumstances where a human has the advantage in being able to anticipate events, which no autopilot can sense, typically in a heavy following sea. The following advice should improve efficiency when sailing using your Tillerpilot:

1. When sailing close to the wind, it is easy to forget to trim the mainsail, allowing excessive weather helm to build up. Where a human helmsman would quickly complain, the autopilot will struggle on and the boat will be sailed less efficiently. Whereas a human normally likes to feel some weather helm, this is not necessary for the functioning of the Tillerpilot. Power consumption, wear and drag will be greatly reduced, if the mainsail is freed or reefed a little sooner than normal when sailing manually.
2. It is also advisable, when sailing close hauled, to set a course a few degrees free of that normally sailed under manual control, to avoid luffing into the wind.
3. When running dead downwind, a human pilot can see visual signs warning him if the boat is about to gybe, which the Tillerpilot cannot sense – it is advisable not to sail as close to the gybe as you may do when sailing manually.
4. When broad reaching or running fast, particularly with quartering waves, a helmsman will naturally apply periodic larger angles of helm than when beating or sailing slowly. This is the equivalent of increasing rudder Gain, and it may be a good idea to adjust the Gain on the Tillerpilot. Many people prefer to find a compromise setting, which is used for all sailing, but with practice it can be optimised for different conditions, e.g. low for motoring in a calm sea, or high for running fast. If the Gain is set too low, the boat will go off course, because insufficient rudder is applied in time; if the Gain is too high, the boat will overcorrect, increasing power consumption.
5. The Tillerpilot is a highly advanced piece of equipment. However, it would be a mistake to become complacent. As with all electronic navigational equipment, it is an aid to navigation and should not be used as a substitute for conventional navigational practice. Remember – Maritime Law requires that you keep a good look out at all times.

6.2 Fault finding

Symptom	Probable Cause	Remedy
When engaged, the pilot immediately applies a large helm angle and increases course error.	<ul style="list-style-type: none"> Tillerpilot is configured for Port hand setting but installed on Starboard side (or vice versa). 	<ul style="list-style-type: none"> Refer to section 4.1.
After functioning normally course is suddenly lost and the Tillerpilot goes into Standby Mode.	<ul style="list-style-type: none"> Power interrupted briefly, or low voltage. Cable used to socket too small. Intermittent connection. 	<ul style="list-style-type: none"> Increase size of cable. Check all connections. Charge batteries. Uprate batteries.
Helm is hard over and alarm is continuously on.	<ul style="list-style-type: none"> Steerage way insufficient to control course, or sails are aback. Pulsing is a correct safety feature when tiller is at full travel. 	<ul style="list-style-type: none"> Reset the vessel on course and re-engage pilot
Power socket is live, but pilot is not on.	<ul style="list-style-type: none"> Socket is wired incorrectly. 	<ul style="list-style-type: none"> Check wiring of socket (section 5.2).
Loss of course under Steer To Wind Mode.	<ul style="list-style-type: none"> Apparent wind has become too light to give a consistent direction. 	<ul style="list-style-type: none"> Change to Compass Mode.
Cannot select Steer To Wind Mode.	<ul style="list-style-type: none"> Masthead unit is not connected. SimNet system is not switched on or powered. Required NMEA sentence not being transmitted. 	<ul style="list-style-type: none"> Check connections. Check system is on. See section 6.3 & check NMEA connections.
Cannot select Nav Mode.	<ul style="list-style-type: none"> GPS/Chart Plotter not connected. Waypoint not active. Wrong NMEA format is being used. 	<ul style="list-style-type: none"> Check connections. Activate waypoint/route. Check NMEA0183 format is being transmitted by navigational receiver.
Autotack function not working.	<ul style="list-style-type: none"> Pilot is in Nav Mode. Pilot is in Steer To Wind Mode and <ol style="list-style-type: none"> apparent wind is >90° autotack being attempted is in the wrong direction. 	<ul style="list-style-type: none"> Exit Nav Mode. Luff up until apparent wind is less than 90°.
Pilot exits Nav Mode before waypoint is reached.	<ul style="list-style-type: none"> Cross Track Error has exceeded 1.2 Nm. 	<ul style="list-style-type: none"> Reset the vessel on course and re-engage Nav Mode.
Pilot does not hold accurate course in Auto Mode.	<ul style="list-style-type: none"> Fluxgate compass is being affected by interference from nearby magnetic influences (binnacle compass, speakers) or metallic objects (winches, deck hardware etc). 	<ul style="list-style-type: none"> Check compass has been calibrated (section 5.6). Fit external SimNet compass. Replace binnacle compass with bulkhead compass. Relocate objects that are causing interference.

These simple checks should be carried out before seeking technical assistance and may save time and expense. Before contacting your servicing agent please note the Tillerpilot's serial number.

6.3 NMEA sentences received

The NMEA0183 information required for full functionality whilst in Nav mode is as follows:

- Cross Track Error
- Bearing to destination waypoint
- Arrival at waypoint indication
- Magnetic Variation
- Boat Speed

This information is extracted from the following NMEA0183 sentences -

Received	Data
APA	Cross Track Error, bearing to/arrival at waypoint
APB	Cross Track Error, bearing to/arrival at waypoint
RMA	Speed & course over ground & magnetic variation
RMB	Cross track error, bearing to/arrival at waypoint (T)
RMC	Speed & course over ground & magnetic variation
BWR	Bearing to/arrival at waypoint (rhumb line)
BWC	Bearing to/arrival at waypoint (great circle)
VHW	Boat Speed
XTE	Cross Track Error

NOTE

The Cross Track Error (XTE) information has a maximum value of 1.2 Nautical Miles. If the XTE exceeds this while using Nav mode, the Tillerpilot will sound an alarm, exit Nav mode and return to Compass auto mode.

The Tillerpilot also extracts the apparent wind angle from the following NMEA0183 sentences -

Received	Data
VWR	Apparent Wind Speed & Angle
MWV	Apparent Wind Speed & Angle

6.4 Spares & accessories

The following spares and accessories are available from local Simrad agents. Please quote part number when ordering -

HR22	Hand Remote
IS12 Compass:S	SimNet Compass System
IS12 Wind:S	SimNet Wind System
TPPK7	Spare Tillerpin, Mounting Cup & Pushrod End Cap
SKT22/32	Spare Waterproof Bulkhead Socket & Cable Assembly
SPC:2M	SimNet Power Cable 2m
SDC:02M	SimNet Cable 2m
SDC:05M	SimNet Cable 5m
SDC:10M	SimNet Cable 10m

Mounting accessories

Tiller Brackets

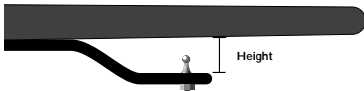

Part No.	Height
TB30	30mm (1.18")
TB60	60mm (2.36")
TB90	90mm (3.54")
TB120	120mm (4.72")

Pedestal & Cantilever Brackets

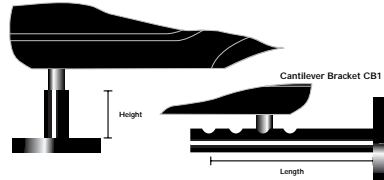

Part No	Height / Length
PB30	30mm (1.18")
PB60	60mm (2.36")
PB90	90mm (3.54")
CB1	135-240mm (5.31-9.44")

Push Rod Extensions



Part No.	Length
PRE30:GY	30mm (1.18")
PRE60:GY	60mm (2.36")
PRE90:GY	90mm (3.54")
PRE120:GY	120mm (4.72")
PRE150:GY	150mm (5.90")
PRE300:GY	300mm (11.81")

6.5 Dimensions

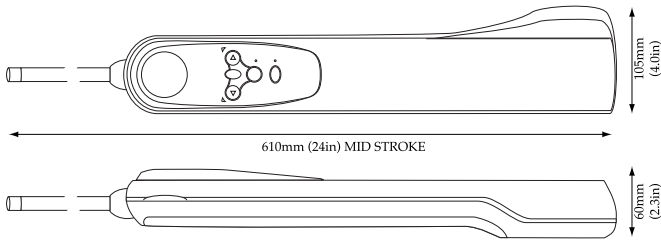

6.6 Specification

Supply Voltage	12v (10-16v) DC
Current Consumption (Typical)	Standby - 60mA Auto - 500mA
NMEA Format	Compliant with NMEA0183 versions 2.0, 2.3 & 3.0 (<i>4800 baud, no parity, 8 bits, 1 stop bit</i>)
Drive System	TP22 - Screw thread TP32 - Recirculating ballscrew
Operating Stroke	250mm (10in)
Peak Thrust	TP22 - 65kg (143lbs) TP32 - 85kg (187lbs)
Hardover time	0kg TP22 - 6.9 secs TP32 - 4.0 secs
	20kg TP22 - 8.0secs TP32 - 4.7secs
	40kg TP22 - 12.0 secs TP32 - 6.0 secs
	50kg TP32 - 8.0 secs
Ambient Temp Range	-10°C to +55°C (14°F to 140°F)
Mounting	Starboard as default (can be reversed)

6.7 Service & Warranty

Your Tillerpilot should seldom need servicing, but will benefit from an application of silicone or Teflon grease to the pushrod and connectors each season, and by keeping the connector's protective cover in place when not in use.

The unit is guaranteed for 2 years from date of retail sale. If it is necessary to have the unit repaired, return it carriage prepaid to the agent in the country of purchase with a copy of the receipted invoice showing the date of purchase. Where possible, return all the components unless you are certain that you have located the source of the fault. If the original packaging is not available, ensure that it is well cushioned in packing; the rigours of freight handling can be very different from the loads encountered in the marine environment for which the unit is designed.

For Worldwide Warranty details, please refer to the Warranty Card supplied with this unit.

A list of official worldwide Simrad distributors is included in the Warranty Card.



MAXIMISING YOUR PERFORMANCE AT SEA

SIMRAD
A KONGSBERG Company